

SURVEY MARKING PRODUCTS

BERNTSEN® | THE SOURCE FOR YOUR SURVEY PRODUCT NEEDS

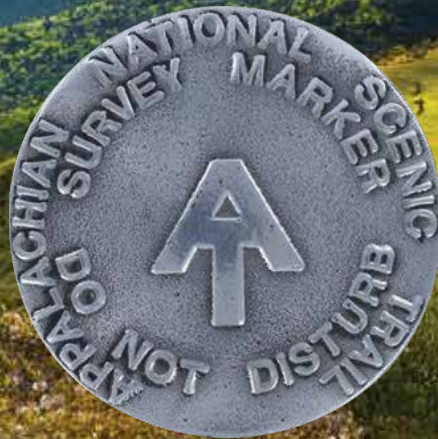

- SURVEY MARKERS & MONUMENTS
- CONCRETE MARKERS & DRILL BITS
- SURVEY NAILS & WASHERS
- REFLECTIVE TARGETS & PRISMS
- RFID-ENABLED MARKING PRODUCTS



FIND US ONLINE
www.berntsen.com



CONTACT US BY EMAIL
surveymark@berntsen.com



ORDER BY PHONE
800.356.7388

MARKING THE INFRASTRUCTURE OF THE WORLD™ | WWW.BERNTSEN.COM

Berntsen®

Berntsen® Marking the Infrastructure of the World™

The year 2015 was bittersweet for Berntsen as we lost our founder and my father, Phil Peterson. He started the business in a garage in 1972 and grew the company to be the premier supplier of survey monuments in the country. Phil "retired" as President in 1990, remained active in the business as Chairman of the Board, and was a strong supporter of Berntsen product innovation right to the end.

Berntsen is proud of our nearly 50-year tradition of providing quality products and excellent customer service. Those values have driven our company from the beginning and you can see those values in our products and our people today.

Phil was just as excited about the future of Berntsen's new products as he was proud of the Berntsen monuments that are marking boundaries throughout the world. We are committed to continuing this legacy of innovation and quality in our products and service.

Rhonda L. Rushing
Rhonda L. Rushing President



*In Memory of Phil Peterson
1924 - 2015
Founder of Berntsen International, Inc.*

CONTACT US



OFFICE HOURS:
MONDAY-FRIDAY
8:00 am - 4:30 pm CST

TELEPHONE:
North America: 800-356-7388 (Toll-free)
Outside North America: 1-608-249-8549

FAX:
North America: 800-249-9794 (Toll-free)
Outside North America: 1-608-249-9794

MAIL:
Berntsen International, Inc.
PO Box 8670
Madison, WI 53708-8670 USA

EMAIL:
surveymark@berntsen.com

WEBSITE:
www.berntsen.com

SHIPPING:
5418 Monument Lane
Madison, Wisconsin 53704 USA

GLOBAL ADDRESS:
43° 09' 12.8333340" N
89° 01' 15.5213676" W
Elevation: 237.442 m
If you are ever in the Madison area we invite you to our facility. We are located off US Highway 51 (north of the Madison airport) at 5418 Monument Lane.

We accept MASTERCARD®, VISA®, DISCOVER®, and AMERICAN EXPRESS®

PURCHASE THE BOOK LASTING IMPRESSIONS®

*by Rhonda L. Rushing,
President of Berntsen International, Inc.*
With sumptuous photography and original writing in many voices, Lasting Impressions® appeals to surveyors and all who cherish American history and geography. Lasting Impressions® brings together compelling first-hand stories from around the United States and gives a glimpse into the legacy of land surveying.

Lasting Impressions **29.95**



GET SOCIAL WITH US

With new product offerings, videos, promotions and conventions happening year round, it's important to stay connected.

FIND US ON



AND CHECK OUT OUR BLOG:
WWW.BERNTSEN.COM/BLOG

Our Berntsen baseball cap is included on all orders of \$250 or more FREE. You can purchase them separately for co-workers, friends and family for \$9.95 each.



ACCESSORIES

Field Bags	18
Hammers	22
Rebar Drivers	22
Stamping Anvils	23
Stamp Sets	23
Traffic Safety Signs	22

CONCRETE MARKERS

Aluminum Markers	14
Bronze Markers	14 & 17
Countersink Drill Bits	15 & 17
Drylok Cement	15
Leveling Markers	14

DRILLS & BREAKERS

Bosch Rotary Hammer Drills	16
Cobra Combi	25

FLAGS & FLAGGING

Aerial Targets	21
Roll Flagging & Flags	21

LOCATORS

Magnetic Locators	24
-------------------	----

REBAR & PIPE CAPS

Metal	4 - 5
Plastic	6 - 7

SIGNS, WITNESS POSTS

Carsonite Posts	26 - 27
Plastic Signs	27

SPECIALTY MARKERS & CONTROL POINTS

Bench Tie	18
Cemetery	18
InfraMarker System	34 - 35
Magnetic Markers (Deep-1)	9
Survey Nails	19
Survey Washers	19
Surveying Targets & Prisms	28 - 30

SURVEY MONUMENTS

Access Covers	12
Drive In Monuments	9
Feno Monuments	13
Pipe Monuments	8
Rod Monuments	10 - 11

SURVEY STAKES

EcoStake	20
Plastic Stakes	20
Stake Drivers	20

REBAR & PIPE CAPS	4-7
-------------------	-----

MONUMENTS	8-13
-----------	------

CONCRETE MARKERS	14 & 17
------------------	---------

COUNTERSINK DRILL BITS	15 & 17
------------------------	---------

DRILLS & BREAKERS	16 & 25
-------------------	---------

SPECIALTY MARKERS & CONTROL POINTS	18-19
------------------------------------	-------

SURVEY STAKES	20
---------------	----

ROLL FLAGGING & FLAGS	21
-----------------------	----

ACCESSORIES	22-23
-------------	-------

MAGNETIC LOCATORS	24
-------------------	----

SIGNS & WITNESS POSTS	26-27
-----------------------	-------

REFLECTIVE TARGETS & PRISMS	28-30
-----------------------------	-------

BERNTSEN SMART MARKERS	34-35
------------------------	-------

SUREGRIP™ REBAR CAP WON'T SHIFT OR WOBBLE!

NEW
SureGrip
TECHNOLOGY™

The insulators in our new rebar caps are now made of a single, thicker piece of plastic. Our improved insulators won't shift or wobble during installation, which means your cap is straight on the rebar.

Berntsen was the first company to recognize that some dissimilar metals cause corrosion. Our rebar caps with plastic insulators – first of their kind – solved this problem by placing a barrier between the metals. We've been making our famous rebar caps for more than 40 years now.

While we were at it we also color-coded the insulator – now you can tell at a glance which cap is sized for which rebar.



QUICKSHIP™ FLAT REBAR CAPS — FREE CUSTOMIZATION, NO CORROSION, UNBREAKABLE

Quickship™ caps ship in 2 business days (or less) after your order is received and customized at no charge! Up to 35 characters can be used on one row, giving you ample room to list your license number and business name. The 2" diameter Flat Caps can also be stamped (using one of our stamp sets – see page 23) for customizing in the field. The unique plastic insulator allows tight, quick placement with no fear of corrosion caused by dissimilar metals, and the forged aluminum construction means that your caps will not break.

STANDARD CENTER DESIGNS

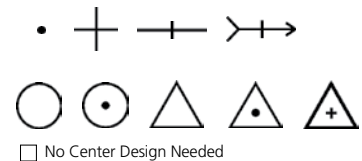

Item #	Description (with 1 row of 35 characters)	100-249	250-499	500+
QSH3200	2" QuickShip Flat Cap for 3/8" Rebar	2.90	2.49	2.39
QSH4200	2" QuickShip Flat Cap for 1/2" Rebar	2.90	2.49	2.39
QSD5200	2" QuickShip Flat Cap for 5/8" Rebar	2.90	2.49	2.39
QSX6200	2" QuickShip Flat Cap for 3/4" Rebar	3.45	2.59	2.49
QSX7200	2" QuickShip Flat Cap for 7/8" Rebar	3.45	2.59	2.49
QSX8200	2" QuickShip Flat Cap for 1" Rebar	3.45	2.59	2.49

Minimum quantities of 100. Limit 35 characters on one row maximum.

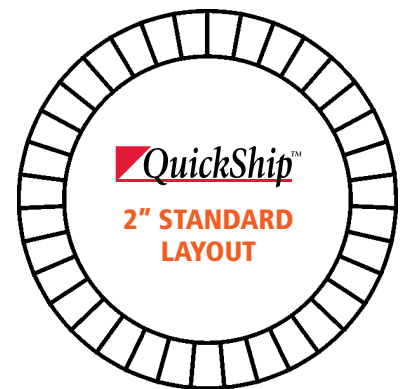



REBAR CAPS

DOMED OR FLAT TOP



REBAR CAPS - DOMED OR FLAT TOP — MORE SIZES, TO FIT MORE INFORMATION

Berntsen Standard Flat or Domed Top rebar caps come in more sizes than our QuickShip caps and can be imprinted with more information. The SureGrip plastic insulator and forged aluminum construction are the same as the QuickShip caps.

CAPS TO FIT 3/8" REBAR - RED SUREGRIP

Item #	Description	1-24	25-99	100-249	250-499	500+
FTH3150	1 1/2" Flat Cap for 3/8" Rebar (Aluminum)	6.85	4.60	3.51	2.29	2.09
FTH3200	2" Flat Cap for 3/8" Rebar (Aluminum)	6.95	4.75	3.85	2.49	2.39
FTH3200BR	2" Flat Cap for 3/8" Rebar (Bronze)	29.15	25.65	23.13	22.23	20.69
RBH3250	2 1/2" Domed Cap for 3/8" Rebar (Aluminum)	9.55	5.25	4.40	3.39	3.19
RBH3325	3 1/4" Domed Cap for 3/8" Rebar (Aluminum)	9.85	5.85	5.15	4.09	3.99
RBH3325BR	3 1/4" Domed Cap for 3/8" Rebar (Bronze)	36.65	32.05	28.91	28.11	26.50

CAPS TO FIT 1/2" REBAR - YELLOW SUREGRIP

FTH4150	1 1/2" Flat Cap for 1/2" Rebar (Aluminum)	6.85	4.60	3.51	2.29	2.09
FTH4200	2" Flat Cap for 1/2" Rebar (Aluminum)	6.95	4.75	3.85	2.49	2.39
FTH4200BR	2" Flat Cap for 1/2" Rebar (Bronze)	29.15	25.65	23.13	22.23	20.69
RBH4250	2 1/2" Domed Cap for 1/2" Rebar (Aluminum)	9.55	5.25	4.40	3.39	3.19
RBH4325	3 1/4" Domed Cap for 1/2" Rebar (Aluminum)	9.85	5.85	5.15	4.09	3.99
RBH4325BR	3 1/4" Domed Cap for 1/2" Rebar (Bronze)	36.65	32.05	28.91	28.11	26.50

CAPS TO FIT 5/8" REBAR - PINK SUREGRIP

FTD5150	1 1/2" Flat Cap for 5/8" Rebar (Aluminum)	6.85	4.60	3.51	2.29	2.09
FTD5200	2" Flat Cap for 5/8" Rebar (Aluminum)	6.95	4.75	3.85	2.49	2.39
FTD5200BR	2" Flat Cap for 5/8" Rebar (Bronze)	29.15	25.65	23.13	22.23	20.69
RBD5250	2 1/2" Domed Cap for 5/8" Rebar (Aluminum)	9.55	5.25	4.40	3.39	3.19
RBD5325	3 1/4" Domed Cap for 5/8" Rebar (Aluminum)	9.85	5.85	5.15	4.09	3.99
RBD5325BR	3 1/4" Domed Cap for 5/8" Rebar (Bronze)	36.65	32.05	28.91	28.11	26.50

CAPS TO FIT 3/4" REBAR - ORANGE SUREGRIP

FTX6200	2" Flat Cap for 3/4" Rebar (Aluminum)	7.45	4.70	3.96	2.59	2.49
RBX6250	2 1/2" Domed Cap for 3/4" Rebar (Aluminum)	9.50	4.95	4.49	3.59	3.39
RBX6325	3 1/4" Domed Cap for 3/4" Rebar (Aluminum)	10.10	5.55	5.04	4.29	4.19
RBX6325BR	3 1/4" Domed Cap for 3/4" Rebar (Bronze)	47.55	39.15	35.87	34.11	32.09

CAPS TO FIT 7/8" REBAR - GREEN SUREGRIP

FTX7200	2" Flat Cap for 7/8" Rebar (Aluminum)	7.45	4.70	3.96	2.59	2.49
RBX7250	2 1/2" Domed Cap for 7/8" Rebar (Aluminum)	9.50	4.95	4.49	3.59	3.39
RBX7325	3 1/4" Domed Cap for 7/8" Rebar (Aluminum)	10.10	5.55	5.04	4.29	4.19
RBX7325BR	3 1/4" Domed Cap for 7/8" Rebar (Bronze)	47.55	39.15	35.87	34.11	32.09

CAPS TO FIT 1" REBAR - RED SUREGRIP

FTX8200	2" Flat cap for 1" Rebar (Aluminum)	7.45	4.70	3.96	2.59	2.49
RBX8250	2 1/2" Domed Cap for 1" Rebar (Aluminum)	9.50	4.95	4.49	3.59	3.39
RBX8325	3 1/4" Domed Cap for 1" Rebar (Aluminum)	10.10	5.55	5.04	4.29	4.19

PIPE CAPS FOR SCHEDULE 40 PIPE

PC6200	2" Flat Cap for 3/4" ID Pipe (Aluminum)	7.25	4.60	4.05	3.77	2.98
PC8200	2" Flat Cap for 1" ID Pipe (Aluminum)	7.30	5.55	4.54	3.85	3.26

- There's no charge to stamp eleven or more caps. Please see page 32 for stamping layout.
- SETUP charge for stamping less than eleven \$35.00 • Rebar drivers \$63.00 (on page 22 of catalog)

BEST Pricing

Rebar & Pipe Caps

NEED MORE PRINTING, SIZES, COLORS? YOU NEED MORASSE!

- Available with your name & number at no extra cost
- Easy to read raised letters
- High-quality UV stabilized polyethylene to protect against fading with color throughout for long life.
- Can be field stamped with steel stamp set
- More durable than other plastic caps - More characters available (smallest size holds up to 81 characters)
- Available with closed center (F style) or open center
- Unique open center allows bar to 'mushroom' over cap during driving - helps prevent removal of cap
- Easy to install and difficult to remove



MORASSE PLASTIC SURVEY CAPS — YOUR NAME AND NUMBER FREE!

Item #	Description	200	500	1000	2000	
G41 & G41F	MORASSE 1 3/4" Diameter Plastic Cap for 3/8" Rebar	1.15	1.05	.95	.90	Each
G42 & G42F	MORASSE 1 3/4" Diameter Plastic Cap for 1/2" Rebar	1.15	1.05	.95	.90	Each
G43 & G43F	MORASSE 1 3/4" Diameter Plastic Cap for 5/8" Rebar	1.15	1.05	.95	.90	Each
P41 & P41F	MORASSE 2 3/8" Diameter Plastic Cap for 3/8" Rebar	1.65	1.50	1.45	1.30	Each
P42 & P42F	MORASSE 2 3/8" Diameter Plastic Cap for 1/2" Rebar	1.65	1.50	1.45	1.30	Each
P43 & P43F	MORASSE 2 3/8" Diameter Plastic Cap for 5/8" Rebar	1.65	1.50	1.45	1.30	Each
M41 & M41F	MORASSE 2 3/4" Diameter Plastic Cap for 3/8" Rebar	2.35	2.20	2.05	1.90	Each
M42 & M42F	MORASSE 2 3/4" Diameter Plastic Cap for 1/2" Rebar	2.35	2.20	2.05	1.90	Each
M43 & M43F	MORASSE 2 3/4" Diameter Plastic Cap for 5/8" Rebar	2.35	2.20	2.05	1.90	Each
M44 & M44F	MORASSE 2 3/4" Diameter Plastic Cap for 3/4" Rebar	2.35	2.20	2.05	1.90	Each
C41 & C41F	MORASSE 2 3/4" Square Plastic Cap for 3/8" Rebar	2.45	2.30	2.20	2.05	Each
C42 & C42F	MORASSE 2 3/4" Square Plastic Cap for 1/2" Rebar	2.45	2.30	2.20	2.05	Each
C43 & C43F	MORASSE 2 3/4" Square Plastic Cap for 5/8" Rebar	2.45	2.30	2.20	2.05	Each
C44 & C44F	MORASSE 2 3/4" Square Plastic Cap for 3/4" Rebar	2.45	2.30	2.20	2.05	Each

Available in Bright Orange, Red/Orange, Blue, Yellow, Green, and Pink. • "F" designates closed center • Minimum Order: 200
See page 33 for stamping layout.

MORASSE CAPS — NOW IN STOCK!

The G43F (closed center) Morasse cap for 5/8" rebar, is now in stock with four of the most requested imprints. Survey Marker (yellow), Boundary Marker (pink), Control Point (orange) and Traverse Point (red/orange). Minimum order is 50 caps ready for immediate shipment.

Item #	Description	50+
G43FBM	Morasse 1 3/4" Cap for 5/8" Rebar Orange Boundary Marker	1.45
G43FCP	Morasse 1 3/4" Cap for 5/8" Rebar Orange Control Point	1.45
G43FSM	Morasse 1 3/4" Cap for 5/8" Rebar Yellow Survey Marker	1.45
G43FTP	Morasse 1 3/4" Cap for 5/8" Rebar Red/Orange Traverse Point	1.45



Berntsen® PLASTIC CAPS

**Now available
in hot stamped
Black Lettering**



BERNTSEN BLACK-FILLED PLASTIC SURVEY CAPS — EASY TO READ AND EASY TO INSTALL

Berntsen plastic caps with black lettering come in a wide array of colors, are easy to read in the field and easy to tap on rebar and pipe for permanent identification.

Item #	Plastic Cap For:	200+	500+	1000+
BFPCAP3	3/8" Rebar & 1/2" ID Pipe	53.00/100	48.00/100	45.00/100
BFPCAP4	1/2" Rebar & 3/4" ID Pipe	54.00/100	51.00/100	47.00/100
BFPCAP5	5/8" Rebar & 1" ID Pipe	56.00/100	52.00/100	48.00/100
BFPCAP6	3/4" Rebar	57.00/100	54.00/100	51.00/100

Minimum order: 200. Prices are per 100. Available in Yellow, Red, Orange, and Pink.

Other colors available upon request.

Rebar & Pipe Caps

STANDARD LAYOUT FOR BERNTSEN CAPS

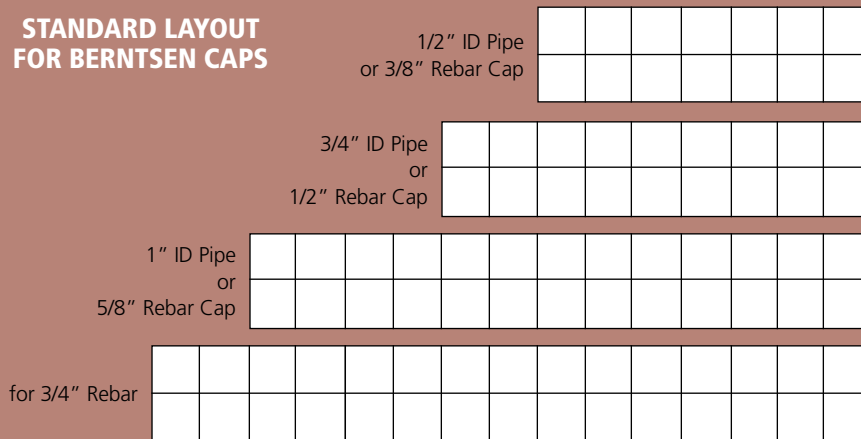

Lettering is straight across only. All come with center "hole".

BERNTSEN COLOR CHOICES



PERMAMARK® PLASTIC SURVEY CAPS* — FADE-RESISTANT AND FREE CUSTOMIZATION

The PERMAMARK is a fast, economical, and long lasting way to personally claim the corners you set. The colors resist fading from UV exposure, and the entire line can be customized with your name and license number at no extra cost.

Item #	Permamark Cap For:	200+	500+	1000+
PERM3000	3/8" Rebar & 1/2" ID Pipe	47.00/100	43.00/100	39.00/100
PERM4000	1/2" Rebar & 3/4" ID Pipe	48.00/100	45.00/100	41.00/100
PERM5000	5/8" Rebar & 1" ID Pipe	51.00/100	46.00/100	43.00/100
PERM6000	3/4" Rebar	52.00/100	48.00/100	45.00/100

Minimum order: 200. Prices are per 100. Available in Yellow, Red, Orange & Pink (Pink is only available in 4000 & 5000 sizes). Yellow will be ordered unless otherwise specified. See page 32 for stamping layout.

* Stamping on PERMAMARK is recessed but NOT black-filled.



Berntsen[®] MAGNETIC PIPE MONUMENTS

Berntsen magnetic pipe monuments are offered in standard, flared and breakaway models designed to meet your surveying needs. Features include:

- Permanent magnet for easy location
- Fastest delivery in the industry
- Exceeds federal specifications
- Custom lengths available
- 3-1/4" customizable cap
- Ease of installation
- Corrosion resistant



FLARED AND NOTCHED-BASE MONUMENTS — EASY TO SET AND THEY STAY PUT!

[See page 34 for details](#)

30" Flared or notched-base monuments are available in aluminum, stainless steel and iron pipe. All stainless steel and iron pipe monuments come with a bronze cap, and all pipe monuments come with a permanent magnet. Berntsen[®] notched-base monuments exceed federal specifications. Pipe can be shipped flared or can be flared in the field.

Item #	Description	1-10	11-24	25-99	100-249	250+
A1NB30	30" Aluminum Notched Base (Not Flared)	40.50	24.95	17.95	15.60	15.10
A1NBF30	30" Aluminum Notched Base (Flared)	40.50	24.95	17.95	15.60	15.10
SS5NBF30	30" Stainless Steel Schedule 5 Notched Base (Flared)				Call for Price	
SSBNB30	30" Stainless Steel Schedule 10 Notched Base (Not Flared)				Call for Price	
SSBNBF30	30" Stainless Steel Schedule 10 Notched Base (Flared)				Call for Price	
IPNB30	30" Iron Pipe Base Monument (Not Flared)	89.05	79.80	75.05	69.45	67.44
IPNBF30	30" Iron Pipe Base Monument (Flared)	89.05	79.80	75.05	69.45	67.44



STANDARD ALUMINUM MONUMENTS — BUILT-IN MAGNET MAKES THEM EASY TO FIND

30" Standard aluminum pipe monument with cast aluminum base that houses a strong, permanent magnet.

Item #	Description	1-10	11-24	25-99	100-249	250+
A130	30" Aluminum Standard (Cast Magnetic Base)	63.45	47.95	41.20	35.00	34.00



BREAK-OFF MONUMENTS — LOCATION IS PRESERVED EVEN IF CAPS ARE KNOCKED OFF

The break-off pipe monument is 30". When base and cap are added the overall length is about 34".

Monuments are available with aluminum or polystyrene bases, and aluminum, stainless steel or PVC pipe.

Item #	Description	1-10	11-24	25-99	100-249	250+
A1BR30	30" Aluminum Break-Off (Alum. Cap, Pipe, & Base)	71.05	50.75	46.00	41.00	34.00
A2BR30	30" Alum. Break-Off (Alum. Cap & Pipe, Plastic Base)	56.55	37.70	22.10	21.00	19.50
A3BR30	30" Break-Off (Alum. Cap, PVC Pipe, Plastic Base)	60.70	41.00	34.75	33.50	31.85

The lengths of the monuments shown on this page are actually 30 – 34 inches long. The "30 inch" designates the pipe portion of the monument.

Custom length monuments are available upon request. Please call, email or fax for price quotation.

Check out our DEEP-1[®] magnetic markers for reference points on page 9.



DRIVE IN MONUMENTS



WETLANDS MONUMENTS — FOR STABILITY IN LOOSER SOIL

These wider, thicker monuments are more stable in wetlands, swamps, riverbanks, and other moist soils, and are used by the U.S. Fish & Wildlife Service.

Item #	Description	1-10	11-24	25-99	100-249	250+
F130	30" Aluminum Drive-in Cone Monument	62.90	45.35	40.75	39.35	35.00

Call for pricing on custom lengths



"G" SERIES OF DRIVE-IN PISTON MONUMENTS — LIGHTWEIGHT AND QUICK TO INSTALL

The all-aluminum "G" Series monuments are sturdy, lightweight, and much easier to install than concrete bound monuments - in most soils you just drive them in! This makes them perfect for surveys where speed of installation is a main concern. All of the drive-in monuments have magnets installed to aid location with a magnetic locator, and all can be customized to your specifications.

Item #	Description	1-10	11-24	25-99	100-249	250+
G130	30" Aluminum Drive-In Piston	31.80	23.50	21.30	20.55	19.50
G2 CAP	3 1/4" Aluminum Tap-On Cap for G1	16.60	10.75	8.55	8.25	7.60
G3250	30" Aluminum Drive-In with 2 1/2" Cap	45.40	25.70	22.25	21.45	20.60
G3325	30" Aluminum Drive-In with 3 1/4" Cap	47.60	30.10	25.55	24.65	23.50

The lengths of the monuments shown on this page are actually 30 – 34 inches long. The "30 inch" designates the pipe portion of the monument. Custom length monuments are available upon request. Please call, email or fax for price quotation.



SSDR130 DRIVE-IN ROD MONUMENT — PRE-INSTALLED CAP SAVES TIME

30" Driveable 9/16" stainless steel rod with 1-1/2" or 3-1/4" forged bronze cap. Drive directly on the bronze cap with urethane-faced hammer (like our Lixie hammers on page 22). Monument features a welded stainless steel flange that anchors the monument firmly in the ground with a powerful magnet installed on top of rod.

Item #	Description	1-10	11-24	25-99	100-249	250+
SSDR130	30" Stainless Drive-in Monument w/ 1-1/2" Cap	61.55	52.85	48.75	46.60	45.50
SSDR13035	30" Stainless Drive-in Monument w/ 3-1/4" Cap	102.30	87.80	81.05	77.50	75.50



DEEP-1® MARKERS — LOW COST MAGNETS REALLY LIGHT UP LOCATORS

DEEP-1 Markers are a low cost way to preserve underground locations. These colorful, permanent magnets are also an approved way to mark section corner reference points. They're easy to install - just bury them vertically near the monument! Two color ranges are provided, one coded for sectional survey use, one coded for marking utilities.

DEEP-1 Underground Magnetic Marker for Surveys

Item #	Description	1-299	300+
DEEP1S	DEEP1 Metallic Silver (NE quadrant)	2.20	1.80
DEEP1FP	DEEP1 Fluorescent Pink (SE quadrant)	2.20	1.80
DEEP1C	DEEP1 Clear (Under the Monument)	2.20	1.80
DEEP1FB	DEEP1 Fluorescent Blue (SW quadrant)	2.20	1.80
DEEP1FO	DEEP1 Fluorescent Orange (NW quadrant)	2.20	1.80



*Deep-1 Magnetic Markers are packed 300/case. For less than full case quantities unit price is \$2.20 each.

SECTIONAL ROD MONUMENTS FOR CONTROL

Preserve the accuracy you work hard to achieve. Berntsen sectional rod monuments can be extended to any depth desired for any level of stability and accuracy. All of our sectional rod monuments come with our exclusive vibration-resistant thread that keeps the rods tightly together while driving. Our most stable driveable monument and sleeved rod monuments will move less than a millimeter in any direction over several years. Standard rod monuments are usually driven in until they reach refusal or until stable ground has been reached. They are still subject to some movement as surrounding soil swells and shrinks with temperature change.

Top Security Rod Monuments are the same as the standard rod monuments, except that 3 aluminum fins are added to the top section to improve stability. These monuments are generally used with a benchmark access cover and backfill, and may be set deeper.

The NGS-style Sleeved Rod Monument with floating sleeve is our most stable driveable monument. The grease-filled sleeve allows the soil around the upper part of the monument to expand and contract without affecting the rod's vertical location. When driven to refusal and set as directed, long-term testing has shown that sleeved rod monuments will move less than a millimeter in any direction over several years.



ROD MONUMENTS Drive Until Refusal, Then Cut To Fit

Rod monuments are a series of stainless steel or aluminum rods, usually 3 ft. (915 mm) long, that are driven into the ground either until they reach refusal or when stable ground has been reached.

A domed cap is then tapped straight onto the rod.

The rod can be cut at any stage if refusal is reached.

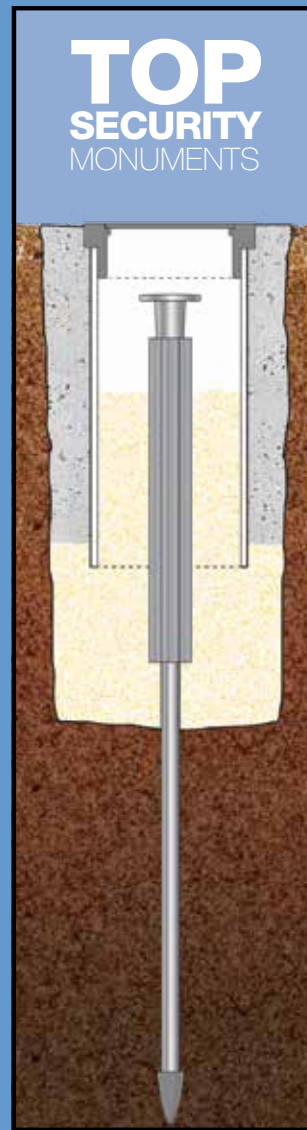

TOP SECURITY ROD MONUMENTS Finned Rod Stabilizes Monument

These are the same as the rod monuments except, for the top section, a security rod with three aluminum fins is used. This increases the stability of the mark.

All sections of the monument, including the top security section, can be driven straight into the soil, or the top section can be isolated from the top soil as shown above.

The fins of the top security section can be peeled back with vice grips if it is necessary to cut the top section. This enables the cap to be tapped on.

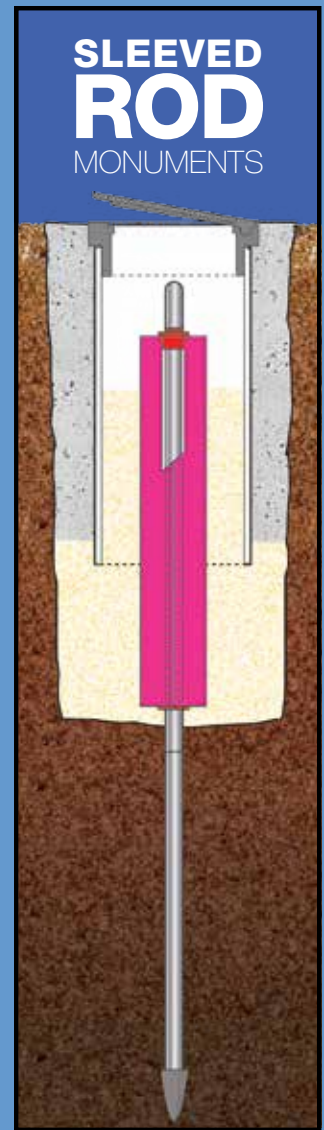

SLEEVED ROD MONUMENT WITH FLOATING SLEEVE The Best System Available For Long-Term Stability

Where a rod monument is to be used for precise vertical measurements, the top section is encased in a grease-filled plastic sleeve, thus isolating the rod from any movements of the surrounding soil. The sand backfill also helps in this process.

A stainless steel datum point is usually used instead of a domed cap and an access cover would usually be fitted to protect the mark.

SECTIONAL ROD MONUMENTS

Item #	Description	1-99	100-249	250+
MSS91604	9/16" Dia. x 4' Stainless Steel Rod with Thread		call for price	
MSS12	9/16" Stainless Steel Drive Point	11.00	10.65	9.95
MSSDP1	Stainless Steel Spherical Datum Point	13.60	12.35	11.05
MHRR1	3/4" Diameter x 1' Aluminum Rod with Thread	11.85	11.00	9.85
MHRR2	3/4" Diameter x 2' Aluminum Rod with Thread	13.85	12.70	11.30
MHRR3	3/4" Diameter x 3' Aluminum Rod with Thread	10.26	9.47	8.75
MHRR4	3/4" Diameter x 4' Aluminum Rod with Thread	15.65	14.98	14.30
MHRR5	3/4" Diameter x 5' Aluminum Rod with Thread	17.25	16.45	15.25
MHDR12	Spiral Point for 3/4" Rod	4.40	4.05	3.85
MHDRP1	Aluminum Spherical Datum Point for 3/4" Rod	10.70	8.75	8.49
M13	Locking Connector Thread for 5/8", 3/4", & 9/16"	1.35	1.15	0.98
DSLKM	Disc-Lock Washers for 3/4" Rod (pair)	2.05	1.75	1.65
RODMAG	1/4" Diameter x 1/2" Magnet for Rods	0.90	<i>(Any Quantity)</i>	

Also Available 5/8" Diameter Aluminum Rod with Thread

call for price

TOP SECURITY RODS

Item #	Description	1-99	100-249	250+
MTSDR3	3/4" x 3' Top Security Rod with Thread	28.10	25.75	23.15
MTSDTI	Threaded Insert for 3/4"	8.85	8.50	8.10

TOP SECURITY SLEEVES

Item #	Description	1-99	100-249	250+
TSS3	Top Security Sleeve, 3' (with endcaps)	15.90	14.75	14.34
TSSGREASE	NO-TOX Grease for TSS (Fits Std. Grease Gun)	10.65	<i>(Any Quantity)</i>	

SURVEY CAPS FOR SECTIONAL/TOP SECURITY RODS

Item #	Description	1-24	25-99	100+
HDR14	3 1/4" Domed Cap for 3/4" Rod with Magnet	9.40	6.70	6.40
HDR15	2 1/2" Domed Cap for 3/4" Rod with Magnet	8.10	5.70	5.40
RBS325BR	3 1/4" Bronze Domed Cap for 9/16" Rod with Magnet	31.50	27.60	26.20
MTSD14	3 1/4" Domed Aluminum cap for 3/4" Top Security Rod with magnet threaded insert and Disc-Lock washers	16.85	13.00	12.40

FLOATING DATUM CAP FOR SLEEVED ROD MONUMENT

The Floating Datum Cap is available in aluminum or bronze and designed to fit over our 3/4" aluminum rod or the 9/16" stainless steel rod. This cap will give you the identification you need without disturbing your accuracy.

Item #	Description	1-24	25-99	100+
RBD325CH	3 1/4" Aluminum Floating Datum Cap for 3/4" Rod	11.25	8.45	8.10
RBS325CHBR	3 1/4" Bronze Floating Datum Cap for 9/16" Rod	32.60	29.80	27.85

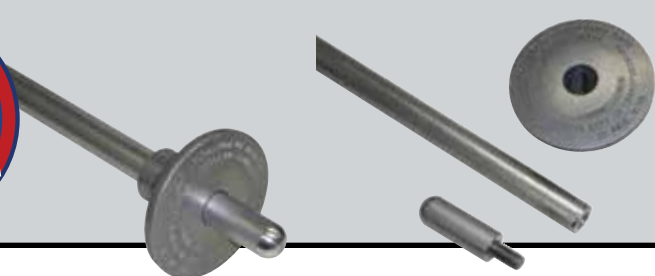

BERNTSEN ROD MONUMENT INSTALLATION VIDEO

ONLY AT
BERNTSEN.COM



Get the right rod monument for your project. Berntsen's free video in the download section on www.berntsen.com helps you choose the right monument, explains NGS standards, and includes clear, step-by-step installation instructions with helpful animated sequences.

Berntsen

ACCESS COVERS

PRESERVE, IDENTIFY, COVER
YOUR HARD WORK.

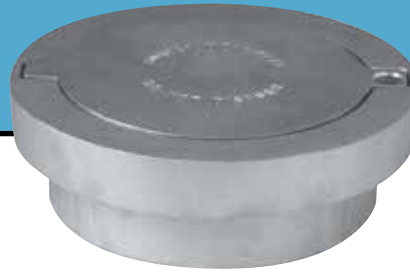

Power Adapter

BENCHMARK ACCESS COVERS — TWO STYLES, BOTH BOND TIGHTLY TO STANDARD PVC SIZES

Our Benchmark Access Covers are intended for use with our Sectional Rod Monuments. They come in 2 styles: NGS style is based on the NGS benchmark with raised hinges and is intended for off-road use, and our BMAC6 covers are heavier duty and made with flush hinges. Covers match the 5" or 6" PVC used to install rod monuments and we sell the perfect adhesive for a tight bond. Tamper-proof screws and setting tool also available. Order eleven or more and get free stamping on covers!

Item #	Description	1-10	11-24	25-99	100+
BMAC1	NGS Style Access Cover for 5" & 6" PVC (Exposed)	58.65	56.50	54.95	54.45
BMAC6*	Access Cover for 6" PVC (Recessed Hinge)	61.75	57.20	52.65	50.30
TAM3	Tamper-Proof Tool for BMAC6	24.15 (Any Quantity)			
5PVC	5" Schedule 40 PVC Pipe	12.25 /Ft.			
6PVC	6" Schedule 40 PVC Pipe	17.40 /Ft.			
UV6800	Adhesive for BMAC/PVC Pipe (Fits Std. Caulk Gun)	14.95 /10.2 oz. Cartridge			
UV6800-3	Adhesive for BMAC/PVC Pipe 3.7oz. (Squeeze Tube)	8.95 each			

*BMAC6 Access Covers available with optional tamper-proof screws; order TAM3 Tamper-proof Tool for access.

There's no charge to stamp eleven or more covers.

DRIVING ADAPTERS — SET BERNTSEN RODS FASTER WITH CUSTOM ADAPTERS

Power Driving Adapters and Manual Driving Adapters are made from a special steel that is precision machined and specially hardened for use with the exclusive features of the rods and other components in the Berntsen Rod System. Both are supplied with a hardened M1DPA steel driving pin. Power driving adapter (PDA) will fit Cobra Combi, Pionjär 120 or any machine with a 7/8" hex chuck. The manual driving adapter includes a handle to steady the driver from a safe distance while a hammer is swinging.

Item #	Description	Each
MDA	Manual Driving Adapter	96.80
PDAP	Power Driving Adapter for 7/8" x 4¼" Hex Chuck	133.90
PDA118X6	Power Driving Adapter for 1 1/8" x 6" Hex Chuck	143.15
M1DPA	Steel Drive Pin for 5/8", 3/4" or 9/16" Rod	17.00



Manual Adapter

OUR FENO DRIVEABLE SURVEY MARKERS REQUIRE NO DIGGING

SEE OUR FENO INSTALLATION VIDEO
BERNTSEN.COM

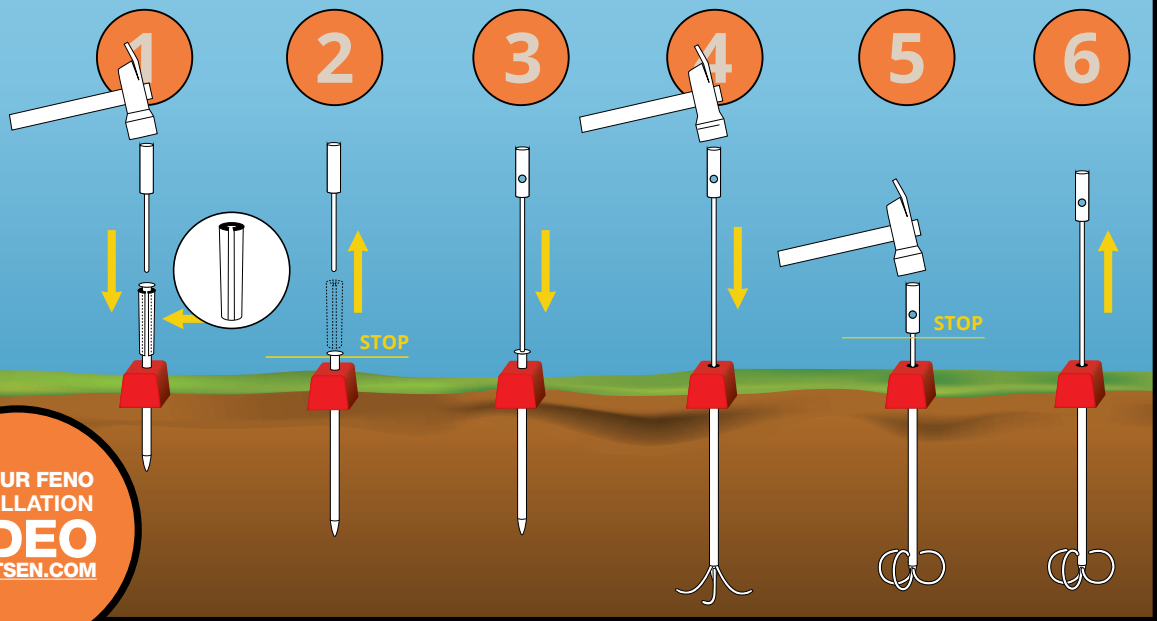

FENO® DRIVEABLE ANCHORED SURVEY MARKERS — SUPER-SECURE, SUPER-FAST, NO DIGGING

A super-secure monument that requires no digging! The galvanized iron FENO series is as easy to drive in as any rod monument. When the 6-step process is complete, the marker has 'roots' that anchor it into the ground. The FENO system comes in 3 lengths - 13.8", 23.6" and 39.4" - and several cap styles. Three tools are needed to set the FENO markers: a driver that sets the pipe, an extension sleeve that forces the 'roots' through the pipe and into the soil, and a ground plate that prevents the marker from sinking into the ground during installation. Tools sold separately. See our website for complete installation instructions.

Item #	Description	1-10	11-24	25-99	100-249	250+
F50ARA	2" Aluminum Cap for 350 & 600mm FENO Spike	13.15	7.90	6.05	5.50	5.30
F50ARB	2" Aluminum Cap for 1000mm FENO Spike	13.15	7.90	6.05	5.50	5.30
F50BRA	2" Bronze Cap for 350 & 600mm FENO Spike	19.05	16.05	15.05	14.30	14.00
F50BRB	2" Bronze Cap for 1000mm FENO Spike	19.05	16.05	15.05	14.30	14.00
F89ARA	3-1/2" Aluminum Cap for 350 & 600mm FENO Spike	17.75	11.35	9.50	9.10	9.00
F89ARB	3-1/2" Aluminum Cap for 1000mm FENO Spike	17.75	11.35	9.50	9.10	9.00
F89BRA	3-1/2" Bronze Cap for 350 & 600 FENO Spike	42.45	37.25	34.70	32.55	31.80
F89BRB	3-1/2" Bronze Cap for 1000mm FENO Spike	42.45	37.25	34.70	32.55	31.80

There's no charge to stamp eleven or more caps. Please see page 32 for stamping layout.

Item #	Description	Each
F350SPK	350 mm (13.8") FENO Mark (spike only - no cap)	18.00
F600SPK	600 mm (23.6") FENO Mark (spike only - no cap)	20.00
F1000SPK	1000 mm (39.4") FENO Mark (spike only - no cap)	40.00
F350TOOLKIT	Driver, Extension Sleeve & Ground Plate for 350mm FENO Spike	74.15
F600TOOLKIT	Driver, Extension Sleeve & Ground Plate for 600mm FENO Spike	80.35
F1000TOOLKIT	Driver, Extension Sleeve & Ground Plate for 1000mm FENO Spike	138.00
F90	Polyroc Monument Block for 350 & 600 mm FENO Spike	13.90
F90NTL	Natural Rock Monument Block for 350 & 600 mm FENO Spike	13.90
F110	Polyroc Monument Block for 1000 mm FENO Spike	41.70
<i>(Polyroc Blocks are available in Red, White, & Yellow. Please specify color when ordering)</i>		
F350/600SQA	Square Aluminum Top for 350 & 600mm FENO Spike	19.80
F1000SQA	Square Aluminum Top for 1000mm FENO Spike	22.10
F300PHPLW	300mm Square Photogrammetric Plate for 350 & 600 FENO Spike (white)	1.90
F50PLCAP	50mm Diameter Plastic Cap for 350 & 600mm FENO Spike	1.60



CONCRETE & LEVELING MARKERS

Concrete Markers

CONCRETE MARKERS

NOTCHED, FLARED STEMS HOLD TIGHT IN CONCRETE

BERNTSEN CONCRETE MARKERS & ROCK TABLETS

Berntsen aluminum & bronze CD style concrete markers have a 3/4" diameter x 2" long notched stem to hold firmly into concrete or rock. The CD series is only available in 2" diameter tops. Berntsen's aluminum and bronze C style markers are the equivalent of the Corps of Engineers Type 1 disc, and can be customized with your imprint. The C style is an orbital forged marker made with a split-style flared solid stem.

The RT35 resembles the 3-1/2" C style models, but is made with 4 flared legs for better resistance, which makes this marker more vandal proof.

A magnet can be attached (CAPMAG) to the underside of all our concrete markers, upon request, at a small additional cost. This will allow easy detection with a magnetic locator.

ALUMINUM CONCRETE MARKERS - COLD FORGED 6000 SERIES ALUMINUM

Item #	Description	1-24	25-99	100-249	250+
CD2	2" Domed Concrete Marker (Aluminum)	7.35	6.15	4.65	3.95
C25D	2 1/2" Domed Concrete Marker (Aluminum)	14.35	12.95	11.80	11.05
C35D	3 1/2" Domed Concrete Marker (Aluminum)	13.65	13.35	12.55	12.00
C35F	3 1/2" Flat Concrete Marker (Aluminum)	20.80	18.40	16.15	15.25
C4D	4" Domed Concrete Marker (Aluminum)	17.35	15.70	13.15	12.35
RT35D	3 1/2" Domed Rock Tablet (Aluminum)	19.05	17.60	15.60	14.35
RT35F	3 1/2" Flat Rock Tablet (Aluminum)	22.15	20.70	19.05	18.65

BRONZE CONCRETE MARKERS - ORBITAL FORGED SILICON BRONZE (LEAD FREE)

Item #	Description	1-10	11-24	25-99	100+
CD2B	2" Domed Concrete Marker (Bronze)	15.60	14.10	11.95	10.60
C25DB	2 1/2" Domed Concrete Marker (Bronze)	35.60	32.05	29.90	27.65
C35DB	3 1/2" Domed Concrete Marker (Bronze)	47.95	43.45	39.15	35.50
C35FB	3 1/2" Flat Concrete Marker (Bronze)	54.40	48.15	43.80	39.60
C4DB	4" Domed Concrete Marker (Bronze)	57.55	54.65	49.25	43.70
RT35DB	3 1/2" Domed Rock Tablet (Bronze)	51.55	48.00	43.60	39.15
RT35FB	3 1/2" Flat Rock Tablet (Bronze)	55.50	52.65	46.75	43.55

CAPMAG 1/2" diameter x 1/4" Ceramic Magnet for Markers **0.55** (Any Quantity)

There's no charge to stamp eleven or more markers. Please see page 32 for stamping layout.

LEVELING MARKERS

WORKS WITH LEVEL RODS AND STANDARD PRISM POLES

BERNTSEN CD2L LEVELING MARK SERIES

Perfect for situations requiring horizontal and vertical location, the CD2L features a raised datum point with a small center dimple that works well with flat bottomed leveling rods or standard prism rods. Intended for use in concrete, the CD2L is 2" in diameter and can be customized with a double row of lettering around the perimeter. Available in aluminum alloy or bronze.

Item #	Description	1-24	25-99	100-249	250+
CD2L	2" Leveling Mark with Datum Point (Aluminum)	8.30	6.90	5.50	5.15
CD2BL	2" Leveling Mark with Datum Point (Bronze)	16.00	14.30	12.60	11.40

There's no charge to stamp eleven or more markers. Please see page 32 for stamping layout.

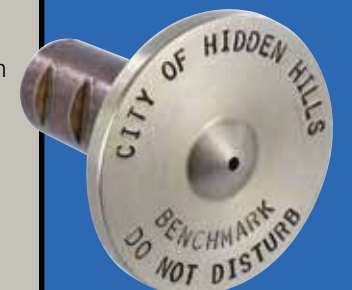
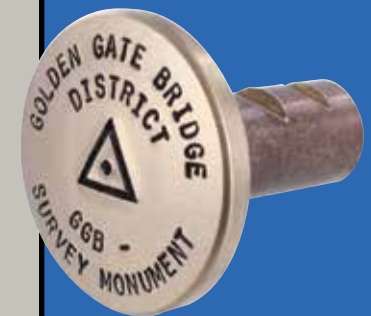

INTRODUCING

BERNTSEN'S EXCLUSIVE SERIES OF COUNTERSINK DRILL BITS

IT'S A NEW WAY TO SET PERFECTLY RECESSED
CONCRETE MARKERS FAST! COUNTERSINK DRILL
BITS AVAILABLE IN ALL FOUR SIZES OF BERNTSEN®
CONCRETE MARKERS

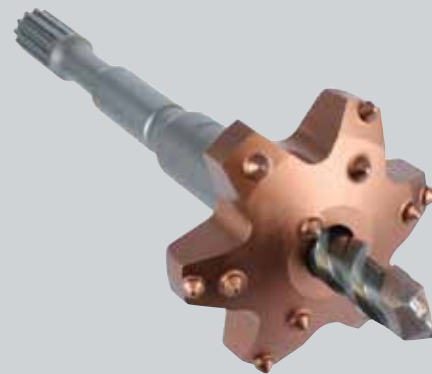

SDS-MAX COUNTERSINK DRILL BITS

Item#	Description	Price
CD2DRLM	2" Countersink Drill Bit (3-piece)	299.00
C25DRLM	2-1/2" Countersink Drill Bit (3-piece)	329.00
C35DRLM	3-1/2" Countersink Drill Bit (3-piece)	409.00
C4DRLM	4" Countersink Drill Bit (3-piece)	429.00

(Works w/ Corded SDS-Max drill, see page 16)

*These drill bits countersink top of marker only (not the stem).
We suggest a 1" drill bit to create the stem hole.*

SDS-PLUS COUNTERSINK DRILL BITS

Item#	Description	Price
CD2DRLP	2" Countersink Drill Bit (3-piece)	299.00
C25DRLP	2-1/2" Countersink Drill Bit (3-piece)	329.00
C35DRLP	3-1/2" Countersink Drill Bit (3-piece)	409.00
C4DRLP	4" Countersink Drill Bit (3-piece)	429.00
HA1020	Adapter, Spline to SDS-Plus Chuck	97.85

(Works with 36-Volt hammer drill, see page 16)

SPLINE CHUCK COUNTERSINK DRILL BITS

Item#	Description	Price
CD2DRLS	2" Countersink Drill Bit (3-piece)	299.00
C25DRLS	2-1/2" Countersink Drill Bit (3-piece)	329.00
C35DRLS	3-1/2" Countersink Drill Bit (3-piece)	409.00
C4DRLS	4" Countersink Drill Bit (3-piece)	429.00

*These drill bits countersink top of marker only (not the stem).
We suggest a 1" drill bit to create the stem hole.*

DRYLOK® — EASY-TO-USE CEMENT, JUST ADD WATER!

DRYLOK Fast Plug is simple to use – just add clean, room temperature water to this hydraulic cement. DRYLOK will set up in just minutes, depending on conditions. Comes in 4 lb. and 10 lb. cans.

Item#	Description	Price
FAST PLUG	DRYLOK Fast Plug (4 lb. can)	13.35
FAST PLUG 10	DRYLOK Fast Plug (10 lb. can)	29.95

BOSCH® ROTARY HAMMER DRILLS

**BOSCH 36-VOLT SDS-PLUS
CORDLESS ROTARY HAMMER
HITS HARDER AND DRILLS
FASTER! CHARGE BATTERIES
FASTER! WORK FASTER!**

Bosch's 36-volt cordless rotary hammer drill is the fastest, hardest hitting cordless rotary hammer drill available – it drills 50% faster than the nearest competitor and packs 2.2 ft.-lbs. of impact force! Litheon 36V batteries charge to 80% of capacity in just 30 minutes, and last longer than other 36V batteries.

The tool-free chuck is easy to use, protects from dust, allows 36 chisel positions, and locks bits in securely for 100% power transfer. End charging guesswork with battery temperature and charge indicator built into the included charger.

And, of course, you get all the other great Bosch features, like comfortable ergonomically cushioned grips, integral clutch, variable speed trigger for accuracy, and three-mode selector that switches between rotary hammer, rotary only, and hammer only.

The complete system includes carrying case, auxiliary handle, depth gauge, charger, and two 36-volt batteries.

BOSCH 36-VOLT SDS-PLUS CORDLESS ROTARY HAMMER

Item #	Description	
11536VSR	1" SDS-Plus Rotary Hammer Drill	865.00

BOSCH 1-5/8" SDS-MAX CORDED ROTARY HAMMER BEST PERFORMING ROTARY HAMMER IN ITS CLASS

Unmatched Power-to-Weight Ratio – 13 Amps, 8.1 ft.-lbs. impact energy. It's made by Bosch, the world's number one maker of rotary hammers. Weighing less than 15 lbs., this hammer drill packs a punch. The one-hand, tool free SDS-Max® system makes changing bits easier than ever while maximizing jobsite productivity. This drill system includes patented cord turret to reduce cord wear, 360° auxiliary side handle and carrying case.

Item #	Description	
11264EVS	Bosch 1-5/8" SDS-Max Rotary Hammer Drill	795.00

SDS-MAX DRILL BITS

Item #	Description	
SM-420-420	SDS-Max Drill Bit 1" x 8" x 13"	48.80

SDS-PLUS DRILL BITS

Item #	Description	
HC2122	SDS-Plus Drill Bit 3/4" x 6" x 8"	41.50
HC2124	SDS-Plus Drill Bit 3/4" x 10" x 12"	44.05
HC2081	SDS-Plus Drill Bit 1/2" x 4" x 6"	12.35
HC2084	SDS-Plus Drill Bit 1/2" x 10" x 12"	23.50
HC2102	SDS-Plus Drill Bit 5/8" x 6" x 8"	23.50
HC2104	SDS-Plus Drill Bit 5/8" x 10" x 12"	35.90
HC2146	SDS-Plus Drill Bit 7/8" x 8" x 10"	53.92

DRILL ACCESSORIES

Item #	Description	
HA1020	Adapter, Spline to SDS-Plus Chuck	97.85
T1854	Blow-out Bulb	24.05
BAT837	36-Volt Battery	326.70



BOSCH blow-out bulb — removes debris from drill hole

CONCRETE MARKERS

CONCRETE MARKERS

BP MARKERS — OUR FASTEST-INSTALLING CONCRETE MARKER

Berntsen BP series copper markers install faster than any other concrete marker we sell. Just drill a hole with our countersink drill bit (sold separately), insert the included expansion plug, and tap in the BP marker. The BP is secure without epoxy or grout and will be flush with the concrete surface, not raised.

BP Markers have a 1.17" diameter face and are available in 3 styles. The BP1 comes with the words "Survey Mark" set slightly below the surface rim and center punch area. The BP1P is similar, except that the choice of lettering (up to 14 characters) is up to you. And the BP2, also customizable with up to 14 characters, is flat on top with no recess.

Item #	Description	25-99	100-249	250-499	500+
BP1-SM	BP Marker w/Anchoring Plug <i>Imprinted with "SURVEY MARK"</i>	2.65	2.35	2.20	2.00
BP1P	BP Marker w/Anchoring Plug <i>Custom imprint with up to 14 characters</i>	3.50	3.30	3.00	2.70
BP2	BP Marker w/Anchoring Plug <i>No recessed center punch - Custom imprint with up to 14 characters</i>	3.50	3.30	3.00	2.70

There's no charge to stamp 25 or more markers. Please see page 32 for stamping layout.

BP1/BP2 COUNTERSINK DRILL BIT — DRILL STEM HOLE AND CAP RECESS IN ONE PASS

This bit is specially designed as an installation tool for the BP series markers. It is the correct width and depth for the BP shank and is fitted with a set of teeth that grind out a recessed area perfectly sized to accept the BP's flat face. The monument ends up flush with the concrete surface. This bit works with hammer drills with a SDS-Plus chuck.

Item #	Description	Each
BPMDDL	SDS-Plus Countersink Drill Bit	125.65
HA1020	Adapter, Spline to SDS-Plus Chuck	97.85

CONCRETE MONUMENTS/BOUNDS

LET US POUR THE CONCRETE FOR YOU!

PRE-CAST CONCRETE MONUMENTS — BERNTSEN CAN CUSTOM DESIGN MONUMENTS

Your customized Berntsen aluminum or bronze concrete markers can now be set directly into a rebar-reinforced concrete monument and shipped on pallets to your door. No more pouring concrete on-site.

Several standard-size monuments are available, or Berntsen can custom design monuments from your blueprints, drawings and specifications. Contact customer service for details.

Item #	Description	11-24	25-49	50+
CM4X4X24	4" x 4" x 24" Concrete Survey Monument*	41.00	38.00	35.00
CM4X4X30	4" x 4" x 30" Concrete Survey Monument*	43.00	40.00	36.00
CM4X5X30	4" x 5" x 30" Concrete Survey Monument*	55.00	47.00	38.00
CM4X6X30	4" x 6" x 30" Concrete Survey Monument*	59.00	54.00	45.00
CM4X6X36	4" x 6" x 36" Concrete Survey Monument*	65.00	61.00	53.00
CM6X6X36	6" x 6" x 36" Concrete Survey Monument*	82.00	78.00	73.00

* Marker sold separately – see page 14 for pricing.

Best Price!

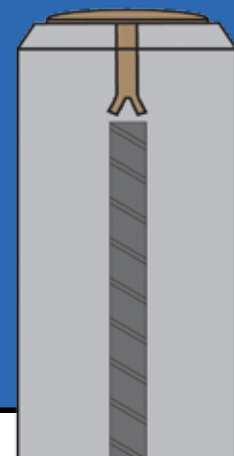
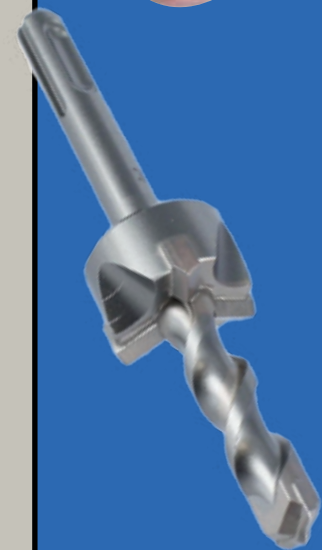
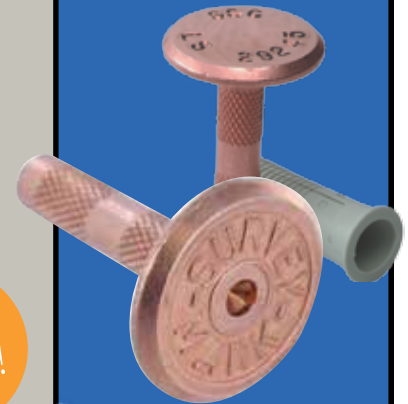

CEMETERY MARKERS AND FIELD BAGS

NEW
SureGrip
TECHNOLOGY™

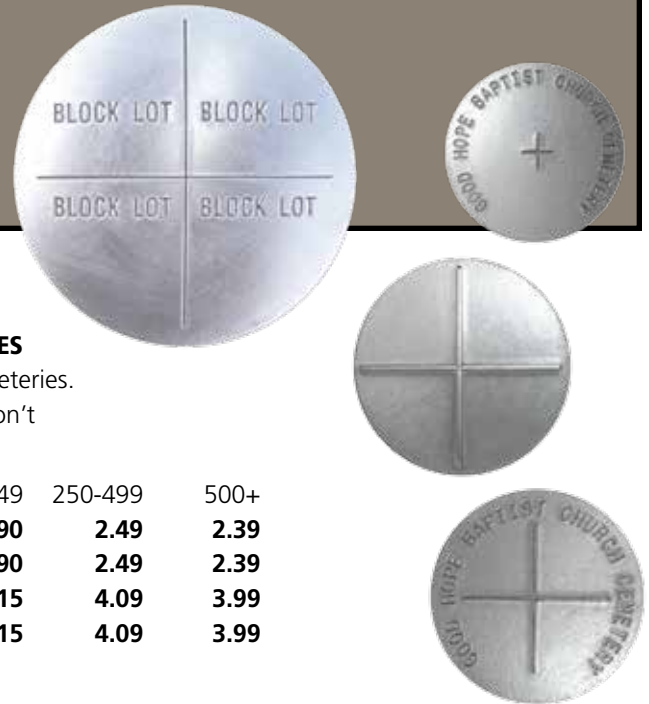

CEMETERY REBAR CAP — SPECIAL IMPRINT SUITABLE FOR CEMETERIES

This special edition cap comes with an imprint suitable for use in cemeteries. Like all our other rebar caps, the cemetery markers are easy to set, won't corrode, and are made of tough aluminum alloy.

Description	25-99	100-249	250-499	500+
2" Cap w/Cross for 3/8", 1/2" or 5/8" rebar	4.75	2.90	2.49	2.39
2" Cap w/1 Row of Lettering for 3/8", 1/2" or 5/8" Rebar	4.75	2.90	2.49	2.39
3 1/4" Cap w/"Block Lot" for 1/2" Rebar	5.85	5.15	4.09	3.99
3 1/4" Cap w/"Block Lot" for 5/8" Rebar	5.85	5.15	4.09	3.99

See the monument cap layout on page 32

BENCH TIE — OUR EASIEST-TO-USE BENCHMARK

Invented by a surveyor for surveyors, the Bench Tie is easy to set, easy to mark permanently, and easy to use once set, with a recessed dimple on top designed to accept a prism pole tip. A good way to set a long-lasting benchmark in a pole, wall or tree, and also useful for setting into a pre-drilled hole in concrete.

Item #	Description	1-19	20-99	100+
BENCHTIE	Vertical Surface Control Point (Yellow)	4.40	3.90	3.55



MULTI-PURPOSE FIELD BAG — REPELS WATER, RESISTS PUNCTURES

The Multi-Purpose Field Bag is designed with the surveyor in mind. It is made of "Tough Duck" PVC backed fabric for maximum strength that will resist tears and repel water. The bottom is layered with "Tough Duck" and a 1000 ballistic nylon fabric to avoid punctures. This bag is 5" x 14.5" x 37" and available in fluorescent orange.

Item #	Description	Each
MFIELDBAG	Multi-Purpose Field Bag	174.85

LATH BAG — CARRY UP TO 50 LATHS IN COMFORT

The Berntsen Lath Bag is made from the same "Tough Duck" fabric and 1000 ballistic nylon as the Multi-Purpose Field Bag. This bag is 5" x 14.5" x 32" and will carry 30-50 pieces of lath. Orange in color and has a convenient loop for a hammer and sturdy shoulder strap.

Item #	Description	Each
LATH BAG	32" Lath Bag	78.15



SURVEY NAILS & WASHERS

DURANAIL — EASIER TO SET, EASIER TO SEE

The DuraNail, from Berntsen, is a remarkable new nail that drives into asphalt with ease. The larger nails have an easy-to-see head with a distinct red cross and center punch, making DuraNails a good choice for control. These magnetic nails come with 'The Magnetizer' to realign the magnetic field after nail is installed, making them easier to locate. Available in several sizes to suit your needs.

Item #	Description	Your Price
DN1	DuraNail 1"	62.55 Package of 200
DN175	DuraNail 1 3/4"	53.05 Package of 100
DN2	DuraNail 2" with Red Cross	84.85 Package of 100
DN3	DuraNail 3" with Red Cross	112.50 Package of 100
DN4	DuraNail 4" with Red Cross	85.95 Package of 50
DN5	DuraNail 5" with Red Cross	99.70 Package of 50
DN8	DuraNail 8" with Red Cross	119.90 Package of 50
THE MAGNETIZER	Realigns nail magnetic field	1.10 each

STEEL NAIL MARKER — POLES DON'T SLIP OFF CENTER DIVOT

Made from solid steel, our Steel Nail Markers are easy to drive into tough blacktop. Each is labeled "SURVEY MARK" and comes with a center divot to provide pinpoint accuracy when used as control points.

Item #	Description	Each
SNM1	Steel Nail Marker	1.40 Package of 100
SNM1B	Steel Nail Marker	1.70 Any quantity outside of a full bag

MAGNAIL® SURVEY NAIL — 2 TO 4 TIMES EASIER TO FIND WITH LOCATOR

- Revolutionary new metal formula retains magnetism
- Larger center point makes nail easier to use
- Magnetized for 2-4 times greater detection with a metal locator

Item #	Description	Your Price
MAGNAIL75	3/4" MagNail	7.40 Per Box of 100
MAGNAIL125	1 1/4" MagNail	14.85 Per Box of 100
MAGNAIL15	1 1/2" MagNail	17.00 Per Box of 100
MAGNAIL2	2" MagNail	21.20 Per Box of 100
MAGNAIL25	2 1/2" MagNail	24.40 Per Box of 100

SURVEY WASHERS — CUSTOMIZABLE, AND LARGE HOLE FITS SURVEY NAILS

Our brass, aluminum, or stainless steel washers can be custom stamped with your name and license number. There's no stamping charge for orders of at least 100 washers. The center hole is sized for "PK" nails, MagNails®, our Steel Nails, or our new DuraNails. This is a fast, inexpensive marking solution for difficult situations.

Item #	Description	25-99	100-249	250-499	500+
AT1	1 1/2" Diameter Aluminum Washer	1.45	1.15	1.00	0.75
SST1	1 1/2" Diameter Stainless Steel Washer	1.50	1.20	1.05	1.00
BT1	1 1/2" Diameter Brass Washer	2.30	2.15	1.85	1.70
BT2	2" Diameter Brass Washer	3.00	2.65	2.50	2.00

No charge for stamping 100+ washers. Maximum of 28 characters (including spaces). See page 32 for stamping layout.

HUB DISCS — STOP LOSING CONTROL WITH THESE BRIGHT DISCS

This bright yellow and florescent orange plastic washer is stamped 'SURVEY MARKER - DO NOT REMOVE' on each side. Works great with our 1" & 1 3/4" DuraNails and Magnails. Sold in packages of 100.

Item #	Description	Your Price
HUBDISC	1 1/2" Plastic Washer stamped "SURVEY MARKER"	18.00 Package of 100



DuraNail

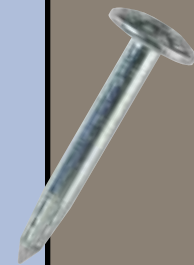

MAKING YOUR MARK IS EASY!

ECOSTAKE™ — RECYCLED, WON'T ROT OR SPLINTER, AND MAGNETIZED

The Berntsen EcoStake is made of recycled plastic and is UV protected. It will not rot, splinter or split, and is not subject to insect damage. Each EcoStake contains a magnet in the top that makes later location a snap. The tough plastic top remains legible and this plastic will accept an impression with a steel stamp set. The EcoStake is available in two colors and three sizes; each stake is imprinted with a bull's eye cross and the words, "SURVEY MARK".



See page 34 for details



EcoStake™

Item #	Description	25-99	100-299	300+
ES3SMO	EcoStake 1" x 16" Orange	4.70	3.80	3.50
ES3SMP	EcoStake 1" x 16" Pink	4.70	3.80	3.50
ES3CP	EcoStake 1" x 16" w/Cross No Imprint Pink	4.70	3.80	3.50
ES4SMO	EcoStake 1 5/8" x 18" Orange	6.30	5.45	5.05
ES4SMP	EcoStake 1 5/8" x 18" Pink	6.30	5.45	5.05
ES5SMO	EcoStake 1 5/8" x 24" Orange	8.30	7.40	6.55
ES5LCO	EcoStake 1 5/8" x 24" w/Cross No Imprint Orange	8.30	7.40	6.55

STAKE DRIVERS — MINIMIZE INJURIES...MAXIMIZE PERFORMANCE

STAKE-PRO drivers for plastic and wood stakes virtually eliminates material waste and promotes maximum safety on the job site.

Item #	Description	Each
SP1X1	Stake Driver 1" x 1"	26.45
SP2X2	Stake Driver 2" x 2"	28.60



BERNTSEN PLASTIC SURVEY STAKES

LIGHTWEIGHT & DURABLE PLASTIC STAKES THAT CLEARLY MARK YOUR TARGET

These plastic stakes are great for land surveying and construction site layout. Mark this plastic stake with a permanent marker for further identification or use the center hole at the top of the stake to attach flagging (next page) for even greater visibility.

- Lightweight & takes up 75% less storage space than wood (a box of 200 fits easily under your arm)
- Durable yet very flexible - will bend back to original shape when stepped on
- Half-moon shape designed to increase stake strength
- Uneven, jagged head helps prevent hammer from slipping
- Flat surface for writing with permanent marker
- Convenient 1 cm hole for attaching additional rope or flagging
- Available in seven bright, APWA color-coded, easy-to-spot colors (pink, white, yellow, orange, red, blue & green)

Item #	Description	50-199	200-599	600-999	1000+
BPS13	13" Plastic Stake	1.95	1.45	1.30	1.10
BPS16	16" Plastic Stake	2.15	1.65	1.50	1.25

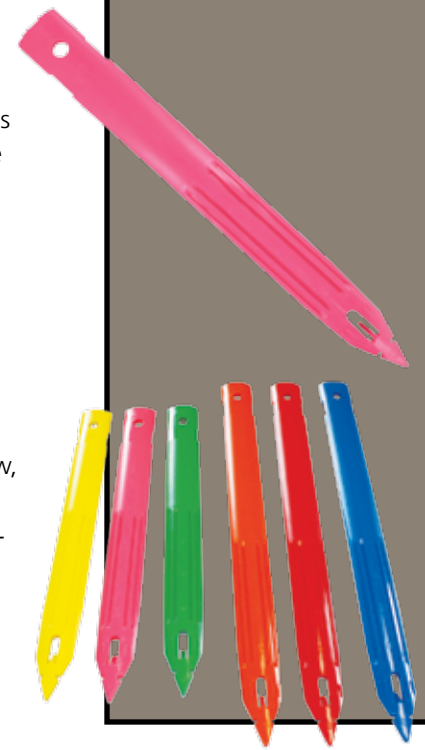

FLAGGING AND TARGETS

MARKING FLAGS

Marking flags now available through Berntsen. Long-lasting material and colors, tear resistant for high performance.

Item #	Description	Plain Flags
MARKING FLAG221	2-1/2" X 3-1/2" on 21" Wire Staff	71.00/box
MARKING FLAG230	2-1/2" X 3-1/2" on 30" Wire Staff	86.00/box
MARKING FLAG421	4" X 5" on 21" Wire Staff	78.00/box
MARKING FLAG430	4" X 5" on 30" Wire Staff	92.00/box
MFTOOL	Marking Flag Insertion Tool	109.00 each

Specify the color: OG = Glo orange, PG = Glo Pink, LG = Glo Lime Green, YG = Glo Yellow, RG = Glo Red, GG = Glo Green, BG = Glo Blue, W = White. Min order: 1000 flags (1 box)

ROLL FLAGGING

Colorful and highly visible, solid color Roll Flagging, temperature resistance -10°F.

Item #	Description	
RF150PG	Solid Color 150 ft/roll Glo Pink	
RF150OG	Solid Color 150 ft/roll Glo Orange	
RF150YG	Solid Color 150 ft/roll Glo Yellow	
RF150RG	Solid Color 150 ft/roll Glo Red	
RF150LG	Solid Color 150 ft/roll Glo Lime Green	
RF150GG	Solid Color 150 ft/roll Glo Green	
RF150BG	Solid Color 150 ft/roll Glo Blue	
RF300W	Solid Color 300 ft/roll White	
<u>12 - 132 Rolls</u>	<u>144 + Rolls</u>	
1.70/roll	1.50/roll	Min order: 12 rolls (1 box)

MARKING WHISKERS

6" Marking Whiskers attach to wood stakes or 60-penny nails (not Included).

Item #	Description	Each
MK WHISKERS	6" Marking Whiskers	132.75/box

Specify the color: OG = Glo orange, PG = Glo Pink, Y = Yellow, W = White, R = Red, O = Orange, G = Green, B = Blue. Min order: 1000 (1 box - 40 bundles of 25)

AERIAL TARGETS

Each target is manufactured with reinforced grommets in each corner and is made of 4 mil PVC. Two patterns available, Bulls-Eye or the Iron Cross.

Item #	Description	Each
AT48BE	48" x 48" w/ Bulls-Eye Pattern	18.00
AT48IC	48" x 48" w/ Iron-Cross Pattern	18.00

AERIAL PANELING

These reusable 4 mil PVC rolls of paneling will save time and labor costs.

Item #	Description	Each
AP12X300	12" x 300' Roll - Black and White	40.00/roll
AP24X300	24" x 300' Roll - Black and White	79.00/roll

FLAG POUCH — ALWAYS KEEP TWO ROLLS HANDY

The Flag Pouch holds 2 rolls of flagging tape and comes with a belt loop attached. It is made of Cordura, a tough, 1000 denier, heavy nylon fabric that resists abrasions, punctures and tears and has a urethane coating to repel water. It is available in Fluorescent Orange.

Item #	Description	Each
FLAG POUCH	Flag Pouch for Flagging Tape	43.50



SURVEY MARKING ACCESSORIES

LIXIE® HAMMERS — AVOID MARRING CAPS... WITH REPLACEABLE SOFT HEADS

Lixie dead blow hammers are quick, easy, and accurate to use, and they are the best way to set monuments onto rebar or pipe without marring the lettering. Dead blow hammers have a shot-filled cavity in the head and replaceable urethane heads that hold up well in the field. Berntsen carries several sizes and a complete line of replacement parts.

Item #	Description	Each
LX3	3 1/2 Pound Hammer w/2" Face/14" Handle	73.20
LX6	6 1/2 Pound Hammer w/2.5" Face/17" Handle	116.70
LX7	7 Pound Hammer w/2.5" Face/32" Handle	172.95
LX10	10 1/2 Pound Hammer w/3" Face/19" Handle	194.15
LX11	11 Pound Hammer w/3" Face/32" Handle	230.20
LX300FU	3 Inch Urethane Replacement Face	43.50
LX250FU	2.5 Inch Urethane Replacement Face	29.70
LX200FU	2 Inch Urethane Replacement Face	19.10
LX3HS	Replacement Handle for LX3	25.45
LX6HS	Replacement Handle for LX6	27.60
LX7HS	Replacement Handle for LX7	41.35
LX10HS	Replacement Handle for LX10	28.65
LX11HS	Replacement Handle for LX11	42.45

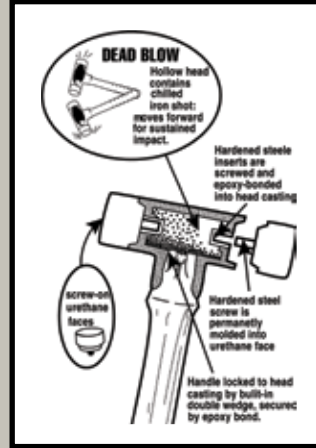

REBAR DRIVERS — CUSTOM DRIVERS WON'T 'MUSHROOM' REBAR

Berntsen rebar drivers are made from strong, heat-treated steel and are exceptionally durable. They provide an ample 2" striking surface and can be used with conventional hammers or our Lixie urethane faced hammers.

Item #	Description	Each
RDRV4	Rebar Driver for 1/2"	63.00
RDRV5	Rebar Driver for 5/8"	63.00
RDRV6	Rebar Driver for 3/4"	63.00
RDRV8	Rebar Driver for 7/8" and 1"	63.00



TRAFFIC SAFETY SIGNS

Roadside surveying is one of the most dangerous professions. Federal regulations - and common sense - require that anyone working in or near traffic lanes be protected by high-visibility clothing and advance warning signs. Our fluorescent orange signs and sturdy metal stands aren't just the law... they're a good idea.

Item #	Description	Each
SS1000	Springless Sign Stand	171.85
SS2000	Sign Stand with Spring	217.50
NR36	36" x 36" Non-Reflective Sign	75.35
NR48	48" x 48" Non-Reflective Sign	92.85

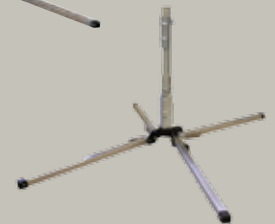

STAMPING SETS

STAMP SET — CUSTOMIZE MONUMENTS IN THE FIELD

You can mark additional field data into your Berntsen survey markers with steel letter and number stamp sets. Combination (COMBO) Stamp Set includes characters A-Z, a period, and figures 0 thru 8 (the 6 is also used as a 9). Standard size(s) 1/8" or 3/16" in stock. Custom sizes also available by special order.

Item #	Description	Each
COMBO18	1/8" Combination Letter & Number Stamp Set	70.00
COMBO316	3/16" Combination Letter & Number Stamp Set	83.00
COMBO14	1/4" Combination Letter & Number Stamp Set	88.00
STL18	1/8" Steel Letter Stamp Set (27 Characters)	55.70
STN18	1/8" Steel Number Stamp Set (9 Characters)	21.75
STL316	3/16" Steel Letter Stamp Set (27 Characters)	64.75
STN316	3/16" Steel Number Stamp Set (9 Characters)	25.45
STN14	1/4" Steel Number Stamp Set (9 Characters)	31.85
RL/N18	1/8" Replacement Letter & Number	7.65
RL/N16	3/16" Replacement Letter & Number	9.25

ROTARY STAMP SET — THREE ROTARY STAMPS REPLACE ENTIRE STAMP SET

The rotary stamp set is easier to carry and use than the regular stamp set. Every letter and number found in the regular set is available on just 3 stamp holders. Just dial the rotary stamp holder to the desired character and stamp away! All 3 holders fit into a handy little box (included) and can be carried in a coat pocket.

Item #	Description	Each
ROS18	1/8" Rotary Letter & Number Stamp Set	395.95
ROS316	3/16" Rotary Letter & Number Stamp Set	395.95

ANVIL FOR STAMPING REBAR CAPS AND MARKERS

Our anvil is a sturdy little tool that provides a good stamping base when hand stamping Berntsen® rebar caps and concrete markers. Just set the anvil on solid ground and insert the cap. Stamping is a lot easier when the cap isn't wobbling!

Item #	Description	Each
ANVIL	Anvil for Stamping Rebar Caps and Markers	48.80

COMBO POUCH — STOP LOSING STAMPS IN THE BACKPACK

The Combo Pouch carries our combination letter/number stamp sets. It is made of Cordura, a tough, 1000 denier, heavy nylon fabric that resists abrasions, punctures and tears and has a urethane coating to repel water. It is available in Fluorescent Orange.

Item #	Description	Each
COMBO POUCH	Pouch for Combo Steel Stamp Set	33.95

TIMBER SCRIBE — THE PROFESSIONAL'S WAY TO MARK TREES NEATLY

If you're a surveyor who scribes trees, you need this timber scribe! Designed by a professional surveyor, this scribe features a double-edged cutting blade that forms a 5/8" radius for right or left hand curved letter and number cuts as well as an additional cutting edge for straight lines. Easy to sharpen with chain saw file, easy to use, and the sturdy leather sheath is included. Made in the USA.

Item #	Description	Each
TIMBER SCRIBE	Timber scribe w/ leather sheath	94.40



SCHONSTEDT MAGNETIC LOCATORS

NEW!!!! SCHONSTEDT® MAGGIE

The Maggie combines the best features of two Schonstedt locators: the sensitivity and precision of the GA-52Cx and the single-handed operation of the GA-92XT.

Item #	Description	Price
MAGGIE	w/ Soft Case & 7-Year Warranty	695.00



NEW!!!
Schonstedt®
Maggie

SCHONSTEDT® GA-52CX

The one piece of survey equipment you'll never have to worry about - it just works! Simple controls and sturdy construction make this locator a must for any survey crew.

Item #	Description	Price
GA52Cx	w/ Hard Case & 7-Year Warranty	687.99



SCHONSTEDT® GA-72CD

The GA-72Cd uses the same circuitry as the GA-52Cx but includes a digital display that shows signal strength and polarity along with more control options.

Item #	Description	Price
GA72Cd	w/ Hard Case & 5-Year Warranty	817.99

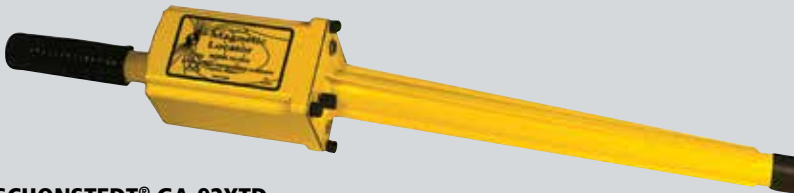

SCHONSTEDT® GA-92XTD

The XT series of magnetic locators is extendable, so they collapse to less than 16 inches and has all the legendary Schonstedt sensitivity in this compact housing. The XTD model includes LCD gain, battery strength and signal strength/polarity display.

Item #	Description	Price
GA92XTd	w/ Hard Case & 7-Year Warranty	796.99

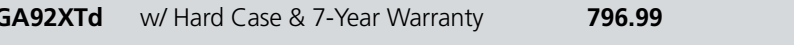

**TRADE-IN
SPECIAL**

Save up to \$300
on a new Schonstedt
Contact Berntsen
for details!



COBRA COMBI

GAS-POWER BEATS MUSCLE POWER!

The Cobra Combi gas-powered drill/breaker is manufactured by the same company that made the Pionjar 120, and combines the Pionjar's sturdy effectiveness with a catalytic converter and a new carburetor. This means the Cobra Combi now meets the tough U.S. EPA Phase 1 emission regulations. The Cobra Combi comes with 2 tools - a flat chisel and a 1-3/8" drill steel - and can be fitted with up to 18 tools that adapt it for cutting, driving, drilling, compacting, breaking concrete and hundreds of other uses. Berntsen recommends the Cobra Combi for driving our Top Security Rod Monuments and, of course, it is superb for driving any size rebar. The new Cobra Combi also features vibration-dampening handles and is easy to start. See our website, www.berntsen.com, for a look at the full line of attachments available.

COBRA COMBI

Item #	Description	Price
COBRA COMBI	Gas-Powered Drill/Breaker	4,795.00

COBRA COMBI RENTAL INFORMATION

The Cobra Combi is a perfect choice for installing our Sectional Rod Monuments or other rod systems that need to be driven "to refusal". The Combi weighs 57 pounds, but with case the shipping weight is 100 pounds. A full line of attachments is available separately from Berntsen. These tools will also fit our previous drill/breaker offering, the Pionjar 120. The hex chuck is 7/8" x 4 1/4".

	Day*	Week*	Month*
Rental Charge:	95.00	500.00	1,900.00

*Plus all shipping charges to and from. Rental starts the day the Cobra Combi ships and ends the day it's received back. Rent with Credit Card only.

DRILLS AND OTHER RELATED ITEMS

Item #	Description	Each
9050 3755	Drill Steel 1-1/4" x 47" Working Length	283.25
9050 4245	Drill Steel 1-5/16" x 31" Working Length	272.95
9050 3769	Drill Steel 1-3/8" x 16" Working Length	262.65
9051 0460	Reamer Bit 3"	618.00
CCR B35	Reamer Bit 3.5"	519.05
9000 0296	Pilot Drill Rod 1" x 31" Working Length	360.50
3083 3237 00	Tie Tamper 3-1/2" x 15-1/2" Working Length	143.70
9245 2823 30	Tie Tamper 3-1/2" x 18" Working Length	167.15
9245 2822 40	Tie Tamper 3-1/2" x 22" Working Length	167.15
3083 3228 00	14" Moil Point	34.55
3083 3229 00	19" Moil Point	35.85
3083 3231 00	Wide Chisel 1-3/4" x 9.5" Working Length	62.55
3083 3230 00	Wide Chisel 1-3/4" x 13.5" Working Length	41.50
3083 3232 00	Asphalt Cutter 3" x 18" Working Length	78.70
9245 2812 90	Asphalt Cutter 5" x 14"	134.00
3083 3233 00	3" Digging Chisel 11" Working Length	122.95
3083 3234 00	Digging Spade 4-3/4" x 13" Working Length	134.00
9245 2813 81	29mm Wedge Set	95.35
9245 2813 51	34mm Wedge Set	102.20
3083 3241 00	Ground Rod Driver 1-11/16" x 7-3/4"	138.25
3083 3235 00	Clay Spade 5" x 14"	138.25
3083 3236 00	Wedge Chisel 1-3/8" x 15"	120.20
9245 2822 80	Driver Blank 2-1/8" x 7-3/4"	120.20
3083 3238 00	Shaft for Tamping Pad	55.30
3083 3252 10	Tamping Pad Round 6"	174.85
3083 3239 00	Tamping Pad Square 7"	157.35



VISIT WWW.BERNTSEN.COM
FOR SPECIAL PRICING OR
PROMOTIONS ON THIS PRODUCT

CARSONITE® FIBERGLASS POSTS

PROTECT THE POINTS YOU SET...PERMANENTLY

Setting a Carsonite Fiberglass Marker is a fast, inexpensive way to mark and protect your monuments, and under normal conditions is permanent. Setting a Carsonite post is a good way to prevent costly monument damage, saving you time and money. On construction sites, a well-placed Carsonite post can keep backhoes and other equipment away from important reference points, preventing long delays and costly layout errors.

Carsonite posts are made from a special fiberglass composite that will not rot or get brittle in harsh weather. Each post is light – about 2 pounds for a 6 foot post – and easy to set in most soil conditions. Carsonite posts come to you with pre-applied standard or custom decals. Driving requires special equipment. A burial depth of at least 18" is recommended.

Item #	Description	<20	20 - 80*	100-280*	300+*
CBM6004SM110	5' Fiberglass Orange Post with SM110 Decal	20.00	16.05	15.15	14.55
CBM7204SM110	6' Fiberglass Orange Post with SM110 Decal	21.85	17.30	16.35	15.70
CBM6004	5' Fiberglass Orange Post w/ No Decal	18.60	14.95	14.65	14.10
CBM7204	6' Fiberglass Orange Post w/ No Decal	20.15	16.20	15.85	14.30

Item #	Description	Each
RMTLD250	Boundary Marker Driver	145.35
RMTLPDR1	Driver for CRM & CIB Posts	211.10
CBMP18	Pilot Hole Punch	49.85
CBMFWDC	Featherweight Driving Cap	43.50
RMTLCPP	Post Puller	361.80
DP100	Pilot Hole Driver	317.20
DECAL	Vinyl Decal Non-reflective (hundreds to choose from online)	3.70
DECAL-R	Vinyl Decal Reflective (hundreds to choose from online)	4.90



CARSONITE ROADMARKER POSTS

The three-rail design provides both flexibility and structural integrity. Two ribs on the side protect decals from impacts while the back rib gives added strength for driving into hard soil.

Item #	Description	<20	20 - 80*	100-280*	300+*
CRM3060	5' RoadMarker Fiberglass Post (No Decal)	20.80	17.30	15.65	14.00
CRM3072	6' RoadMarker Fiberglass Post (No Decal)	24.00	19.20	18.30	17.60

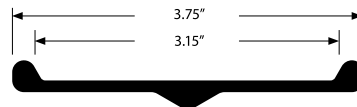

DUAL-SIDED TRAIL MARKERS

This durable yet flexible fiberglass composite post accepts decals on both sides. The raised, reinforced ribs along each side help prevent scratching or removal of decals if impacted.

Item #	Description	<20	20 - 80*	100-280*	300+*
CIB3060	5' Dual Sided Fiberglass Post (No Decal)	18.15	15.10	14.40	14.00
CIB3072	6' Dual Sided Fiberglass Post (No Decal)	22.50	18.60	17.50	16.35

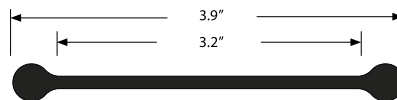

*20 Posts per case. Posts with custom decals, please call for price



See page 34 for details



LIGHTWEIGHT AND REASONABLY PRICED THIN-LINE POSTS AND POLYETHYLENE SIGNS

Hundreds Of Decals To Choose From OR CUSTOMIZE YOUR OWN AT www.berntsen.com



THIN-LINE POST — LIGHTWEIGHT AND INEXPENSIVE, WON'T ROT OR GET BRITTLE

Berntsen's Thin-Line Post, made of reinforced fiberglass, is lightweight, inexpensive, and will not rot or get brittle when exposed to extreme weather. Can be used to mark right-of-way, corners, reference points, and just about anything else. Comes standard in orange, and 3 standard decals are available - R.O.W., Survey Mark, and Boundary. Call us for information on other colors and custom decals. The Thin-Line Post requires a special driver, sold separately, and should be set at least 2 feet deep.

Item #	Description	50	50-99*	100-299*	300+*
TLP5-ORG	5 Foot Fiberglass Post Orange with No Decal	11.40	9.95	9.10	8.50
TLP5-SM-ORG	5 Foot Fiberglass Post Orange with 'Survey Mark' Decal	13.80	11.30	10.80	10.50
TLP6-ORG	6 Foot Fiberglass Post with No Decal	12.45	10.80	10.00	9.25
TLP6-BDY-ORG	6 Foot Fiberglass Post with 'Boundary' Decal	14.10	12.25	11.30	11.00
TLP6-ROW-ORG	6 Foot Fiberglass Post with 'R O W' Decal	14.10	12.25	11.30	11.00
TLP6-SM-ORG	6 Foot Fiberglass Post with 'SURVEY MARK' Decal	14.10	12.25	11.30	11.00
TLPDRV	Thin-Line Driver	106.00	Each		
TLPDECAL	Vinyl Decal Non-Reflective	3.20	Each		

*50 Posts per case

Thin-Line post driver



POLYETHYLENE SIGNS — REASONABLY PRICED, AND CUSTOMIZED FOR YOU

These sturdy polyethylene signs are bright, long lasting, and versatile. They can be marked with any combination of lettering and symbols desired – just send us a sketch. One color custom printing is free, additional colors cost \$.60 per color per sign. Signs come standard in 2 thicknesses and 3 colors – orange, white and yellow. Call us for information on custom sizes and thicknesses.

Item #	Description	25-99	100-499	500+
POLY4X6A	4" x 6" Plastic Signs	8.25	4.40	4.00
POLY6X8A	6" x 8" Plastic Signs	11.35	6.15	5.30

Signs are .055 gauge polyethylene with one color ink

POLY4X6B	4" x 6" Plastic Signs	10.65	5.50	5.00
POLY6X8B	6" x 8" Plastic Signs	13.50	7.80	7.00

Signs are .125 gauge polyethylene with one color ink

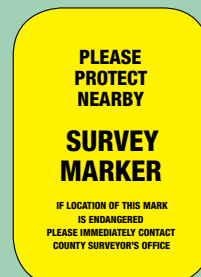

REFLECTIVE TARGETS AND FLAT PRISMS

RS SMART TARGETS — FOR VERIFICATION, DOCUMENTATION & MONITORING

Berntsen International, Inc., has launched a new line of permanent precision survey targets and markers. Designed to facilitate precise building, site layout, and monitoring, all RS Smart Targets are made of tough, UV-resistant materials and are intended for discreet, long term, highly precise control monumentation. The RS System includes over 20 specialized markers for placement on bridges, roads, buildings, towers, railroad tracks, and anywhere else precise, repeatable control is needed. RS Smart Targets typically include a reflective surface for use with most total stations, and a bull's eye or level line (or ledge) for accurate targeting. When placed on building axes or other critical dimensions, RS control markers can be used by most of the trades associated with large survey and construction projects.

ADHESIVE TARGET REFLECTORS

Item #	Description	1-4	5-9	10-24	25+
RSZ2-10	20 x 20 mm Reflective Adhesive Target (10 per sheet)	26.30	18.75	17.20	15.50
RSZ3-10	30 x 30 mm Reflective Adhesive Target (10 per sheet)	30.40	24.40	22.30	20.70
RSZ4-10	40 x 40 mm Reflective Adhesive Target (10 per sheet)	37.60	30.75	28.10	26.50

Item #	Description	1-10	11-24	25-59	60+
RSZ6-4	60 x 60 mm Reflective Adhesive Target (4 per sheet)	26.25	21.65	19.70	18.45

Item #	Description	1-9	10+
RSZ22-1	220 x 220 mm Reflective Adhesive Target (1 per sheet)	46.95	40.95

PLASTIC SMART TARGETS WITH FLAT PRISM (AVAILABLE IN RED OR GREY)

Item #	Description	1-24	25-49	50-99	100+
RS30	Level Target w/ 30 x 30 mm Reflector	8.10	7.10	6.40	5.90
RS40	Level Target w/ Cross Hairs	6.70	4.95	4.10	3.60
RS50	Target w/ 30 x 30 mm Reflector	8.25	7.10	6.80	6.30
RS60	Target w/ 40 x 40 mm Reflector	10.05	8.85	7.35	6.85
RS70	Target w/ Cross Hairs	6.70	4.95	4.10	3.60

LONG DISTANCE TARGETS (AVAILABLE IN RED OR GREY)

Item #	Description	1-24	25-49	50-99	100+
RSAKZ6	Plastic Target w/ 60 x 60mm Reflector	16.75	14.15	12.65	11.75
RSALU22	Metal Target w/ 220 x 220 mm Reflector	85.45	74.55	68.85	65.80

INDOOR CONSTRUCTION LEVEL TARGETS

Protect your work and avoid costly mistakes on-site.

Item #	Description	25-49	50-99	100-249	250+
RS11	Construction Level Target w/ Adhesive Backing	3.40	2.80	2.45	2.25
RS21	Construction Level Target w/ Stubs	3.55	2.90	2.80	2.40

SAVING
TIME &
MONEY
ONE PROJECT
AT A TIME



RSZ6



RS30R



RS50R



RS60G



RSKZ6R



RS11

PROTECT YOUR WORK

AND AVOID
COSTLY
MISTAKES
ON-SITE



RS80R

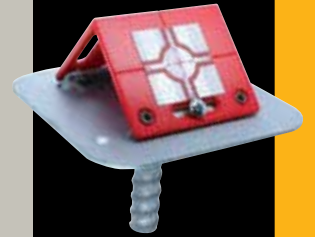

RSAMGR80R



RSAK80R



RS183R



RSL300

REFLECTIVE SURVEY TARGETS & PRISMS GET BETTER DATA AND INCREASE PRODUCTIVITY

Great for back-sights, check shots, elevation references and monitoring situations, reflective RS Smart Targets are the best way to take advantage of your investment in high-tech survey equipment. Save crew time, keep employees out of danger, get better data, and feel more secure about construction layout. Can you afford not to use RS Smart Targets?

PLASTIC SMART ANGLE TARGETS (AVAILABLE IN RED OR GREY)

Item #	Description	1-24	25-49	50-99	100+
RS80	Angle Target w/ 2 Target Reflectors 40 x 40mm	19.85	18.05	15.10	13.85
RS90	Angle Target w/ 3 Target Reflectors 40 x 40mm	24.20	20.90	18.45	17.05
RS100	Angle Target w/ 4 Cross Hairs	14.65	11.90	10.40	9.15

ADAPTER WITH SMART ANGLE TARGETS (AVAILABLE IN RED OR GREY)

Item #	Description	1-24	25-49	50-99	100+
RSAK130	Adapter w/ 2 Target Reflectors 30 x 30 mm	21.35	19.40	17.75	16.65
RSAK80	Adapter w/ Angle Target RS80	34.85	28.15	26.00	24.20

RSAM80	Metal Adapter w/o thread & Target RS80	79.60	67.75	62.25	57.40
RSAMG80	Metal Adapter w/ thread & Target RS80	83.00	71.55	64.80	62.85

SWIVELING SMART ANGLE TARGETS (AVAILABLE IN RED OR GREY)

Item #	Description	1-4	5-9	10+
RS183	Reflective 30 mm Target w/ 180° Swiveling	39.00	34.40	31.55
RS193	Reflective 30 mm Target w/ 360° Swiveling	49.00	44.40	41.55
RS193M	Magnetic Reflective 30 mm Target w/ 360° Swiveling	54.00	49.40	45.55

LASER SCANNER TARGET MARKERS

Item #	Description	1-24	25-49	50-99	100+
RSL300	Laser Scanner Target Marker	7.95	6.90	6.15	5.65

ADHESIVE FOR SMART TARGETS

Item #	Description	Each
UV6800	Multi-purpose Adhesive 10.2 oz. (fits Std. Caulk Gun)	14.95
UV6800-3	Multi-purpose Adhesive 3.7 oz (Squeeze Tube)	8.95



UV6800-3

Reflective Targets & Prisms

MINI SURVEYING PRISMS FOR MONITORING

ACCURACY STARTS AT THE REFERENCE POINT, NOT THE SURVEY INSTRUMENT

For surveying projects that require permanent and precise measurement options over an extended period of time, we offer several varieties of mini prisms. Our newest prisms, the RSMP190 & RSMP290 can be rotated 360° degrees with optional magnets so they can be attached to steel structures without epoxy or bolts. The RSMP180 & RSMP280 can be rotated 180 degrees and multiple prisms can be combined using an integrated connector system for making measurements in different directions while the prisms remain in place.

**NEW
360°
ROTATING PRISM**



RSMP290G



RSMP180



RSMP15



6600-02



RS96



RSFP1

Item #	Description	1-4	5-9	10+
RSMP290M	17.5 mm Magnetic Mini Prism w/ 360° Swivel	120.95	115.95	110.95
RSMP190M	12.7 mm Magnetic Mini Prism w/ 360° Swivel	114.95	109.95	104.95
RSMP290	17.5 mm Mini Prism w/ 360° Swivel	115.95	110.95	105.95
RSMP190	12.7 mm Mini Prism w/ 360° Swivel	109.95	104.95	99.95
RSMP280	17.5mm Mini Prism w/ 180° Swivel	105.95	100.95	95.95
RSMP180	12.7mm Mini Prism w/ 180° Swivel	99.95	94.95	89.95
RSMP15	12.7mm Mini Prism Angle Target	90.95	84.95	79.95

Item #	Description	Each
6600-02	SECO 25 mm L-Bar Mini Prism	91.95

SURVEY STAKE-OUT AID – FITS IN ANY SHIRT POCKET

Stake-Out Aid RS96 was developed specifically for setting out work on the batter boards and on the floor slab. Exact measuring of the survey point on the floor slab often causes major problems particularly in the “final phase” with the last 5-10 cm. The RS96 is placed on the ground and the assistant can use the measuring scales to reproduce and transfer the surveyor’s directions quickly and precisely.

Item #	Description	Each
RS96	Survey Stake-Out Aid	46.95

ALUMINUM PLATE

Fixed point with engraved cross for tripods, prisms and instruments.

Item #	Description	1-4	5-9	10+
RSFP1	Fixed Point Aluminum Plate	76.50	69.55	61.75

LEVELING WALL MARKER

A precision 4” stainless steel mark designed for precise leveling and features evenly spaced ridges for anchoring in walls, rocks and tunnels.

Item #	Description	1-24	25-99	100+
SSLWM	Leveling Wall Marker (4” Stainless Steel)	18.50	16.35	14.75

Is this your first order from us? Yes No

METHOD OF PAYMENT

VISA MasterCard American Express Discover Payment Enclosed

(Please make your check payable to Berntsen International, Inc.)

Name on Card _____ Credit Card No. _____

Date _____ Signature _____ Expiration Date _____ CV2 Code _____

MAIL TO

Type or Print

Company _____

PO Box or Street Address _____

City, State, Zip Code _____

Telephone _____ Fax _____

Signature of Authorized Person _____

Email Address _____

SHIP TO

(Type or Print. Shipments must have street address)

Company _____

Street Address _____

Suite, Room, Building _____

City, State, Zip Code _____

Telephone _____

Attention _____

Title _____

DELIVERY - We ship by UPS or truck freight depending on the total weight and number of packages in your order. Next Day, Second Day Air, and 3 Day Select shipping via UPS is also available. Please ask for details and cost.

PAYMENT - We accept MasterCard, Visa, American Express, and Discover. You can also prepay by check.

SHIPPING & HANDLING - Prices do not include shipping charges. Please call, fax, or email for costs on your order, or add 15% for shipping & handling on BERNTSEN, PERMAMARK and MORASSE products. On all other items, such as CARSONITE, call for costs.

SALES TAX - Wisconsin resident: Add applicable State, City, and County sales tax(es).

CUSTOM DESIGNED DESIGNS AND LOGOS - Call for quotation. Camera-ready artwork may be required. For custom stamped logos we also accept artwork as .tif files. For engraved logos please furnish artwork in .dxf and .dwg file format.

CUSTOM MONUMENTS - We welcome the opportunity to quote on custom survey marker and monument designs to meet your specifications.

TERMS - Terms and prices are subject to change without notice. Because product innovation is a continuing endeavor at Berntsen, specifications and prices are subject to change without notice.

SURVEY MARKING PRODUCTS CATALOG 2016 SUPERSEDES ALL PREVIOUS PRICE LISTS

The unique design and layout of this brochure and the products depicted herein, and the arbitrary, distinctive numbering system for Berntsen products all originated with Berntsen International, Inc. and are the result of years of research by Berntsen to determine not only exactly what our customers wanted, but to best present our customers with the wide range of products available from Berntsen. No copying or reproduction of the format of this brochure or any of the designs, layouts, drawings, or combinations of designs or parts manufactured by Berntsen is permissible without the express written consent of Berntsen International, Inc.. Many Berntsen products are protected by U.S. Patents including 243,159; 243,319; 3,087,945; 4,502,258; 3,748,795; 4,625,473. Other patents pending.

- Prices do not include shipping charges.
- Price list is based on standard stamped lettering only. Please call for quotation on custom made and engraved markers with custom logos.
- Lettering is recessed from the surface.

- Use standard layout forms on reverse side for personalized markers.
- No stamping charge on 11+ markers using standard stamping layout (\$35.00 stamping set-up charge for 1 to 10 markers).
- All prices are in U.S. Dollars.

Office hours are 8:00am to 4:30pm Central Time, Monday through Friday. Voice mail available at all other times. Email and Fax operate 24 hours a day.

QUANTITY	ITEM NUMBER	DESCRIPTION	UNIT PRICE	TOTAL PRICE

*Add 15% for Shipping & Handling on Berntsen, Permamark and Morasse products for delivery in the 48 contiguous states (not including Alaska or Hawaii). For all other items, please call for estimate of shipping charges.

Sub Total		
*15% Shipping & Handling		
Tax (Wisconsin Only)		
Total US \$		

LAYOUTS FOR PERSONALIZED SURVEY MONUMENTS

Enclose this handy drawing with your order for Berntsen Survey Caps or Survey Monuments, or PERMAMARK caps.

It's easy to design your own survey cap!

1. Select a center design (if any desired) or your personalized Berntsen Survey Cap or Survey Monument. Draw that design on the layout for the size cap you are ordering.
2. Fill in blank spaces with the lettering you want on your cap. All letters, numbers, and characters, including periods, take up one full space. Lettering may face "in" or "out" but is usually placed so that one may read the cap from one position.
3. Use the drawing at the bottom of the page for PERMAMARK plastic caps. Standard center designs are not available for PERMAMARK caps. Lettering on PERMAMARK is "straight-across" only.

Note: Drawings are not to scale.

3 1/4", 3 1/2" & 4"

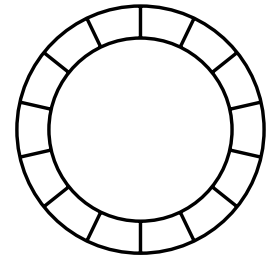
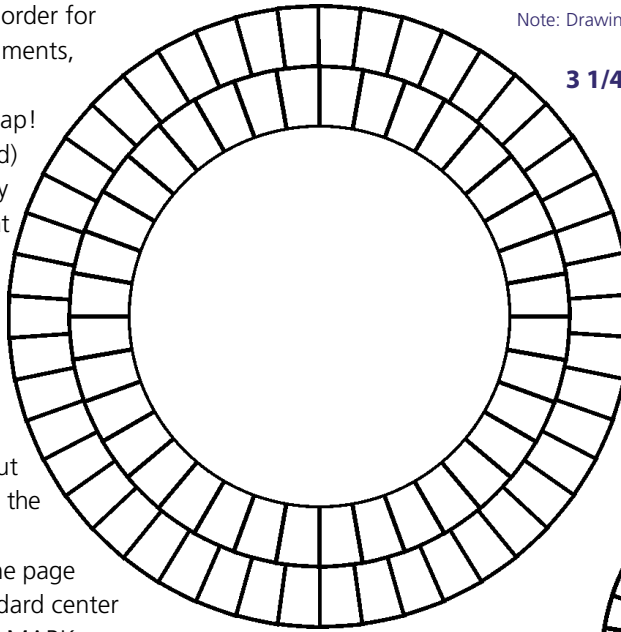

BP1P & BP2 Layout

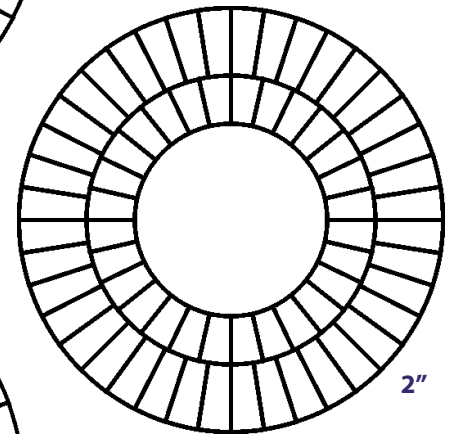

2"

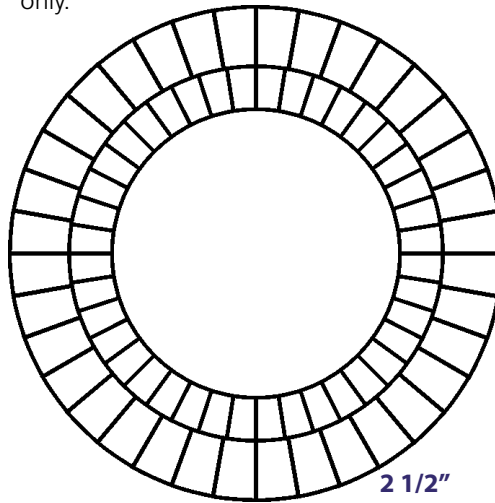

2 1/2"

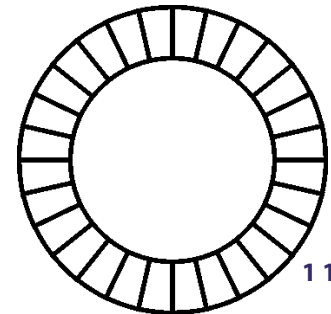

1 1/2"

Standard Center Designs

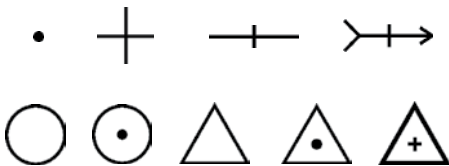

No Center Design Needed

PERMAMARK Color Choices

Yellow Red Orange Pink



Standard Layout for PERMAMARK

Lettering is straight across only. All come with center "hole".

PERMAMARK 1/2" ID Pipe
or 3/8" Rebar Cap

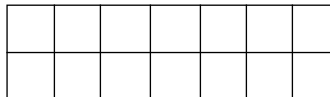

PERMAMARK 3/4" ID Pipe
or 1/2" Rebar Cap

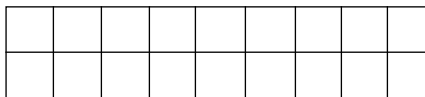

PERMAMARK 1" ID Pipe
or 5/8" Rebar Cap

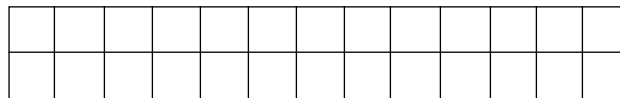

PERMAMARK
for 3/4" Rebar

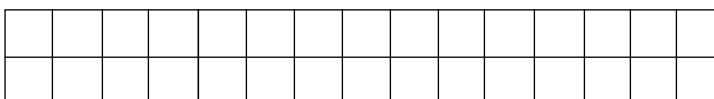

2" Standard Layout

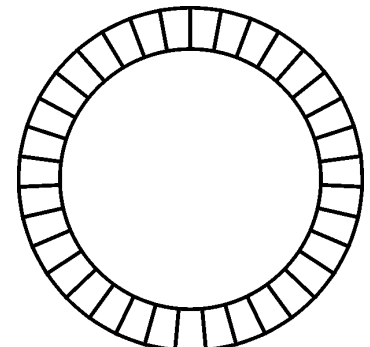

MORASSE® PLASTIC SURVEY CAPS LAYOUT

- Available with your name and number at no extra cost
- Easy to read RAISED letters
- Large diameter cap surface has enough room for stamping additional data in the field with standard steel stamp sets
- Permanently colored...available in bright orange, red/orange, yellow, blue, green, and now pink
- Easy to tap in...difficult to remove
- Unique open center allows bar to "mushroom" over cap during driving...helps prevent removal of cap

Use the layout below for MORASSE plastic caps. Be sure to indicate your style and color choice and send this layout with the order form.

G41 & G41F = 1 3/4" diameter cap for 3/8" rebar
 G42 & G42F = 1 3/4" diameter cap for 1/2" rebar
 G43 & G43F = 1 3/4" diameter cap for 5/8" rebar

P41 & P41F = 2 3/8" diameter cap for 3/8" rebar
 P42 & P42F = 2 3/8" diameter cap for 1/2" rebar
 P43 & P43F = 2 3/8" diameter cap for 5/8" rebar

M41 & M41F = 2 3/4" diameter cap for 3/8" rebar
 M42 & M42F = 2 3/4" diameter cap for 1/2" rebar
 M43 & M43F = 2 3/4" diameter cap for 3/8" rebar
 M44 & M44F = 2 3/4" diameter cap for 3/4" rebar or 1/2" pipe

C41 & C41F = 2 3/4" square cap for 3/8" rebar
 C42 & C42F = 2 3/4" square cap for 1/2" rebar
 C43 & C43F = 2 3/4" square cap for 3/8" rebar
 C44 & C44F = 2 3/4" square cap for 3/4" rebar or 1/2" pipe

All cap numbers ending with "F" have a capped center. Those caps without this designation have a center hole with ribs.

"C" Style (Square)

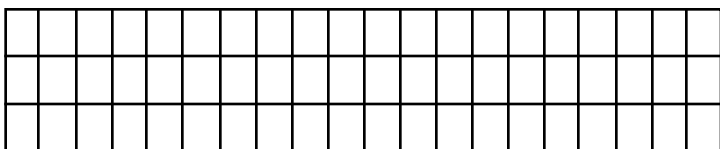
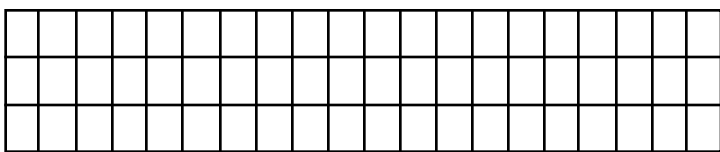

3 lines are available on the upper and bottom part of cap (total 6 lines). On each line: 20 letters of 1/8" or 16 letters of 1/4"

Standard Center Designs

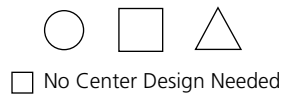

Color Choices

- Bright Orange
- Red/Orange
- Blue
- Yellow
- Green
- Pink

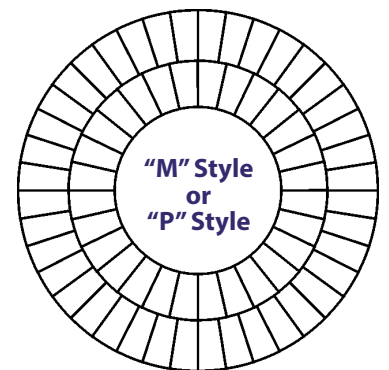
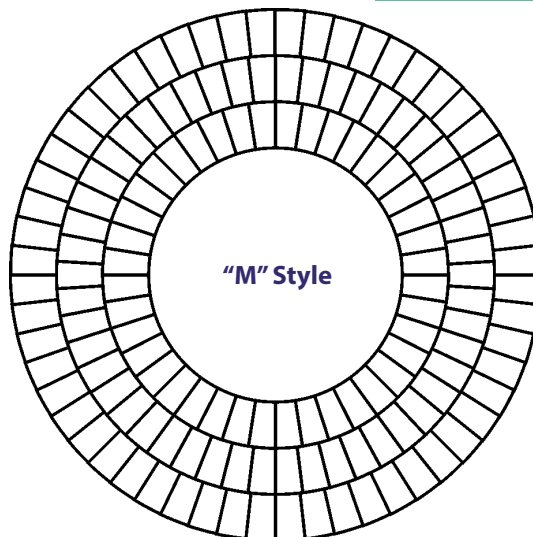
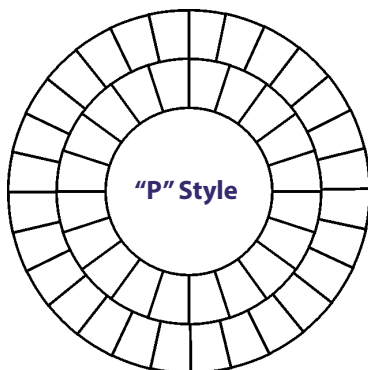
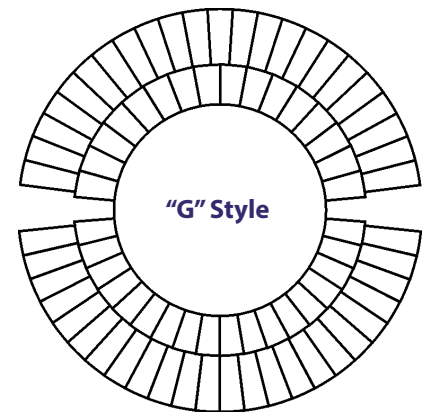
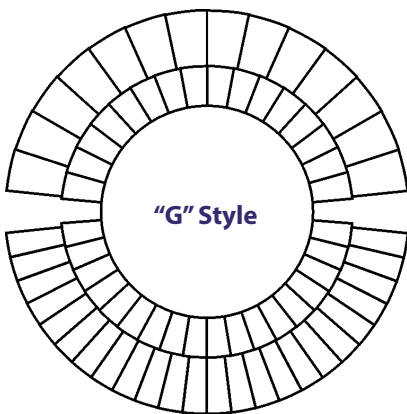

CONNECTING THE PHYSICAL TO THE GIS WORLD IS EASY WITH BERNTSEN SMART MARKERS

Smart Markers – The Internet of Things is here and Berntsen is making it possible with RFID-enabled markers and posts. Berntsen's RFID-enabled markers combine the best of traditional physical markers with the connectivity needed to communicate information.



**RFID
ENABLE
YOUR
Monuments**

RFID-enabled survey markers can expedite location of land survey monuments, increase the amount of information available at a point, audit activity at a location, and facilitate mapping of data into a GIS system.

Berntsen's RFID-enabled markers have the same reliable placement and durability characteristics that you have come to expect from us. The above-ground markers provide easy visibility and the patented below-ground markers are perfect for marking underground utility assets or boundary corners.

Berntsen "Smart" RFID-enabled markers can be combined with a RFID reader and the InfraMarker mobile app for reading and writing tags or integrated to provide a complete smart marking system.

To find out how Berntsen "Smart" marking products and packages can work for you, visit www.inframarker.com, call us at (877)868-8550 to talk to our experts, or get started today by downloading our InfraMarker app using the Google Play Store™.





MARK. MAP. MANAGE.

Your integrated infrastructure marking and tracking solution

- Easy and lightweight
- Simple integration into a GIS
- Real-time, remote field access
- Fast location and identification of field assets
- Supports above and below ground infrastructure tracking
- Enables activity logging for audit tracking and maintenance activities

THE BERNTSEN INFRAMARKER® SYSTEM

New technology can be daunting. That is why we have packaged the RFID-enabled tags, readers, and software into one system. The InfraMarker System is easy to use:

1. Place the monument and/or the underground InfraMarker tag at the point desired.
2. Write the information, data and media to the monument or underground marker using the InfraMarker RFID reader/writer. Key data is written on the marker and transferred to the InfraMarker cloud in real-time along with notes, photos, or video added by the user.
3. Add, view, edit and export data using the InfraMarker web application. Field data is easily integrated into a customer's GIS*.
4. Relocate the marked spot using GPS equipment, the magnetic locator, and the supporting information provided at placement. Once relocated, the tag can be read providing verification and an audit record trail.

**Berntsen is an Esri Partner.*

US Patent No: 9,235,823 B2



Google Play is a trademark of Google Inc.™



Berntsen®

Marking the Infrastructure of the World™

Berntsen International, Inc.

P.O. Box 8670

Madison, WI 53708-8670

Presort Standard
U S POSTAGE
PAID
Madison WI
Permit No 1027

DISCOVER | ONLINE THE ADVANTAGES OF ORDERING

ONLINE CUSTOMIZATION

Create and preview your custom survey markers and monuments before you order. We even keep your previous layouts for easy re-ordering.

REAL-TIME SHIPPING CHARGES

Choose your method of UPS shipping (ground, next-day air, etc.) and we'll calculate your shipping charges as you add to your order.

DELIVERY TRACKING

Tracking number and delivery confirmation sent via email for all orders shipping out of our Madison office.

ONLINE ORDER HISTORY

View order status of all recent orders in one simple interface as well as view a complete order history.



FIND US ON FACEBOOK,
LINKEDIN AND YOUTUBE



Berntsen® is a registered trademark of Berntsen International Inc. Copyright 1997 - 2015
Terms Of Use | Privacy Statement